

LED strip color temperature comparison chart

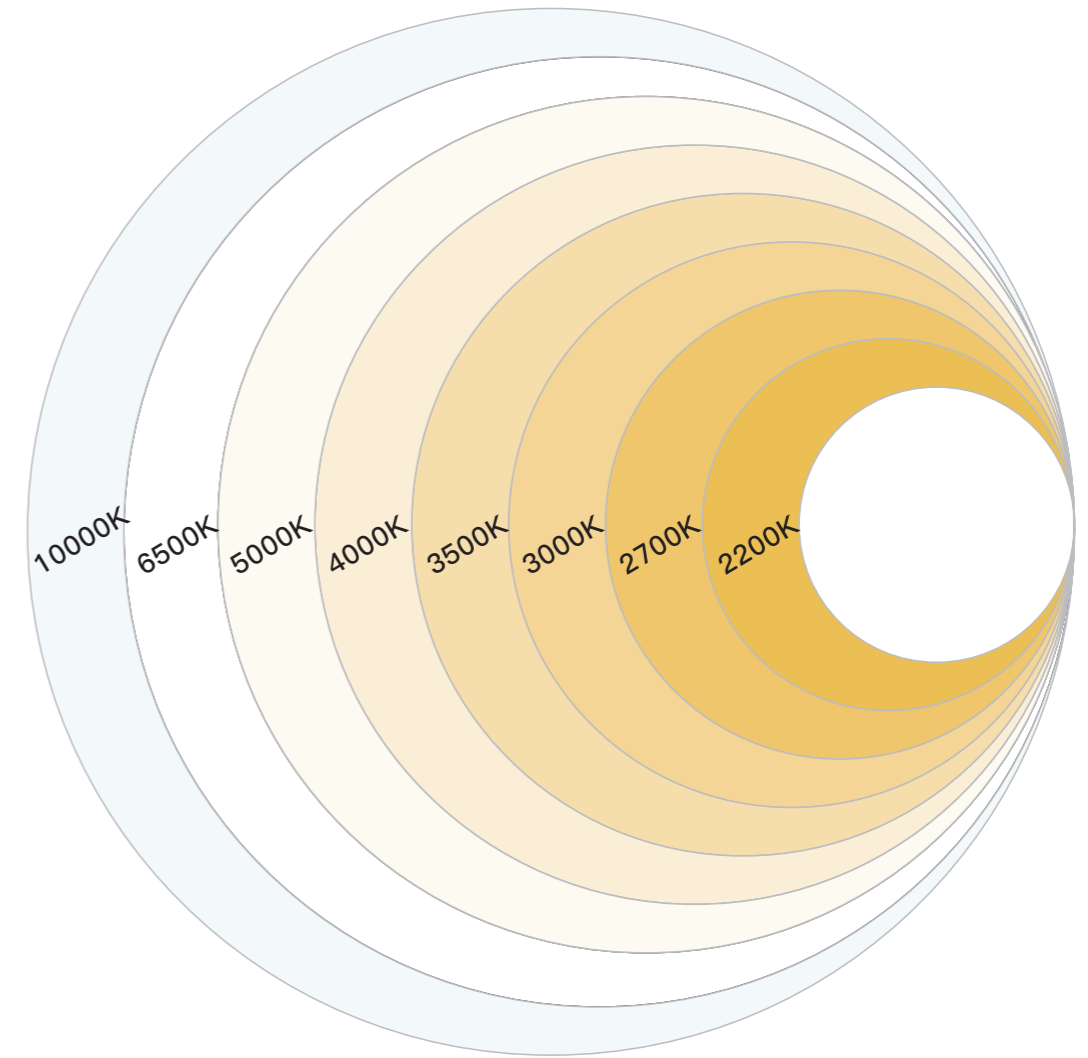

# CONTENTS

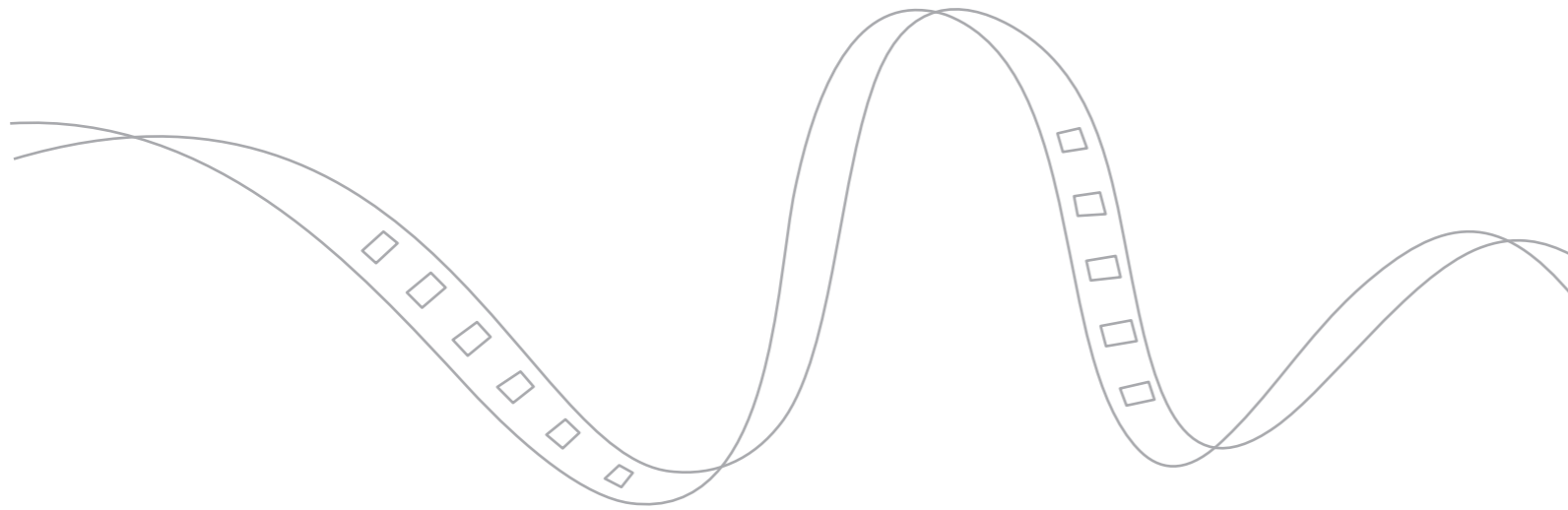

High Efficiency LED Strip 1-8



Narrow LED Strip 9-18



CCT Tubabel LED Strip 19-28



Cut Free LED Strip 29-36

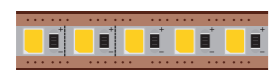

Soldering Free LED Strip 37-44



Regular LED Strip 45-64



Zigzag LED strip 65-72



COB LED Strip 73-82



LED Neon Flex 83-94

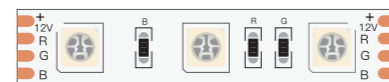

RGB RGBW LED Strip 95-100



High Efficiency LED Strip



High-efficiency LED strips provide high-brightness lighting at lower energy consumption, helping to reduce energy costs while reducing environmental impact

## Feature

1. SMD2835,Cut with 4LED, RA>90
2. Higher energy saving
3. Ideal Light source for LED linear light
4. Hight brightness lighting at lower energy consumption
5. It reduce energy costs while reducing environmental impact

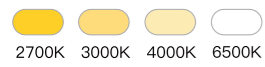

## Electrical Parameters

Light Beads:	2835
LED Qty:	168pcs/m
Width:	5mm
Voltage:	DC24V
Power:	14W/m
CRI:	95
LM/m:	1840
LM/W:	131
Color:	3000K/4000K/6500K



## Cut size

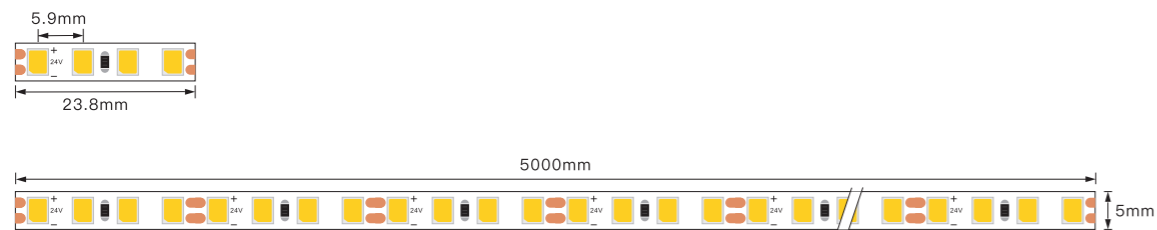

## Feature

1. SMD2835,Cut with 4LED, RA>90
2. Higher energy saving
3. Ideal Light source for LED linear light
4. Hight brightness lighting at lower energy consumption
5. It reduce energy costs while reducing environmental impact



## Electrical Parameters

Light Beads:	2835
LED Qty:	208pcs/m
Width:	5mm
Voltage:	24V
Power:	10.1W/m
CRI:	95
LM/m:	1374
LM/W:	136
Color:	3000K/4000K/6500K



## Cut size

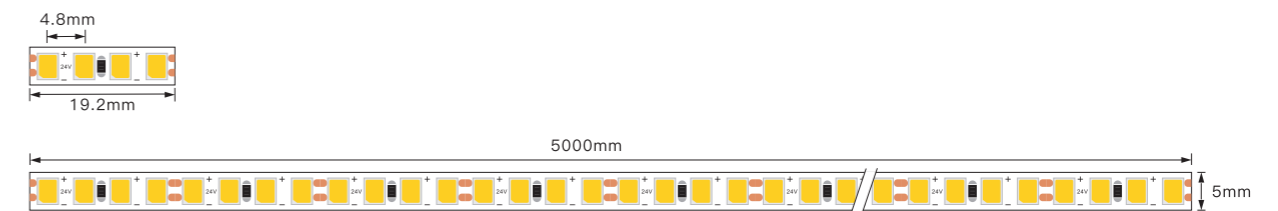

## Feature

1. SMD2835 ,RA>90,Cut with 7LED
2. Higher Energy Saving
3. Ideal Light source for Led Linear Light
4. Hight brightness lighting at lower energy consumption
5. It reduce energy costs while reducing environmental impact

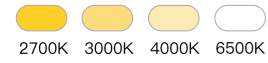

## Electrical Parameters

Light Beads:	2835
LED Qty:	168pcs/m
Width:	5mm
Voltage:	DC24V
Power:	13W/m
CRI:	82
LM/m:	1901
LM/W:	146
Color:	3000K/4000K/6500K



## Cut size

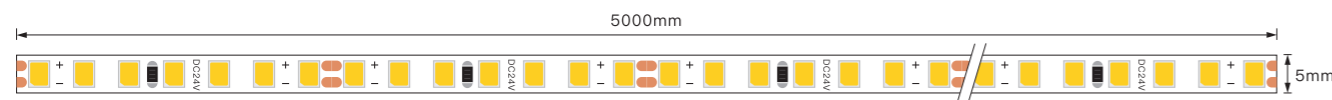
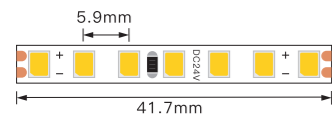

## Feature

1. SMD2835 ,RA>90,Cut with 4LED
2. Higher Energy Saving
3. Ideal Light source for Led Linear Light
4. Hight brightness lighting at lower energy consumption
5. It reduce energy costs while reducing environmental impact

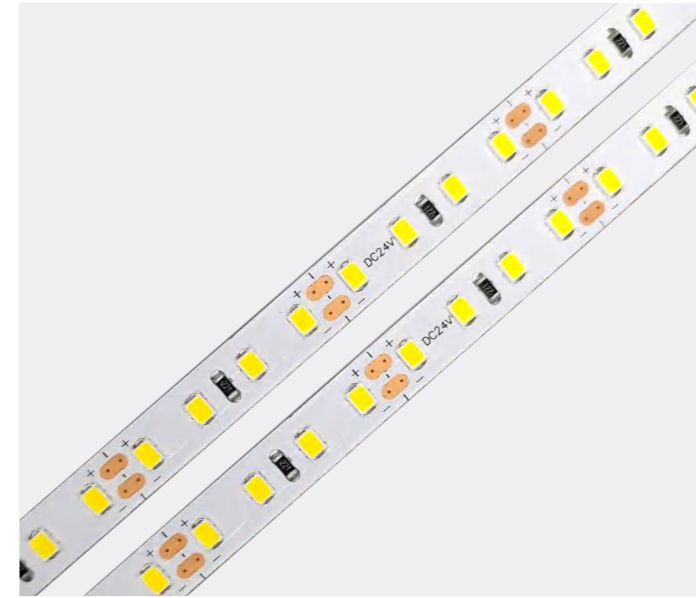

## Electrical Parameters

Light Beads:	2535
LED Qty:	120pcs/m
Width:	8mm
Voltage:	DC24V
Power:	7.1W/m
CRI:	95
LM/m:	1048
LM/W:	146
Color:	3000K/4000K/6500K



## Cut size

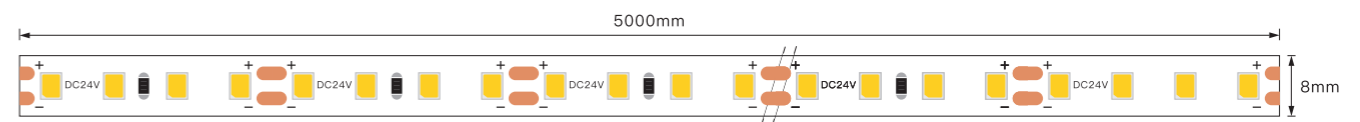
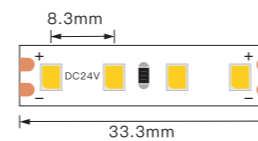

## Feature

1. SMD2835 ,RA>90
2. Higher Energy Saving
3. Ideal Light source for Led Linear Light
4. Hight brightness lighting at lower energy consumption
5. It reduce energy costs while reducing environmental impact

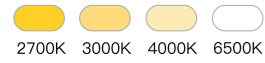

## Electrical Parameters

Light Beads:	2835
LED Qty:	128pcs/m
Width:	10mm
Voltage:	24V
Power:	16.3W/m
CRI:	90
LM/m:	2461
LM/W:	150
Color:	3000K/4000K/6500K



## Cut size

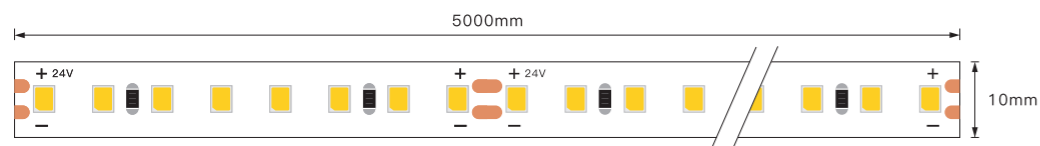
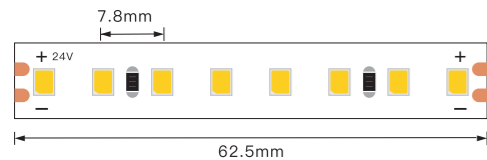

## Feature

1. SMD2835 ,RA>90
2. Higher Energy Saving
3. Ideal Light source for Led Linear Light
4. Hight brightness lighting at lower energy consumption
5. It reduce energy costs while reducing environmental impact

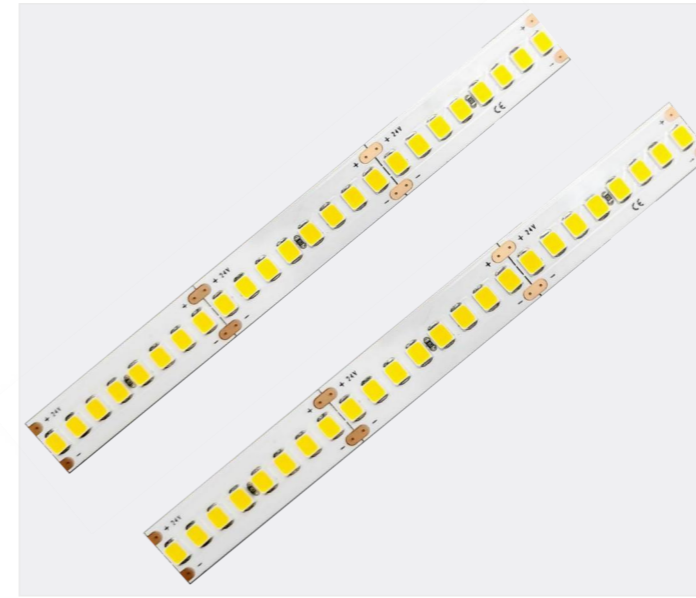

## Electrical Parameters

Light Beads:	2835
LED Qty:	240pcs/m
Width:	10mm
Voltage:	24V
Power:	23W/m
CRI:	90
LM/m:	3783
LM/W:	141
Color:	3000K/4000K/6500K



## Cut size

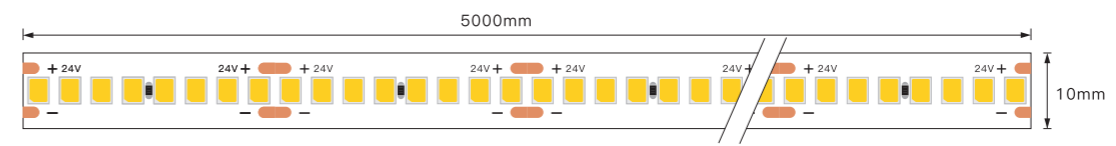
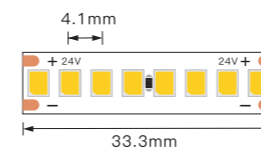



## Narrow LED Strip



- Suitable for very small size profile
- Suitable for installation in narrow spaces
- Suitable for all kinds of furniture

## NW-1515-216-2.6mm

### Feature

1. SMD 1515 LED, RA>90
2. Stable and low light decay, reliability
3. Narrow FPCB width:2.6mm
4. Suitable for very small size profile



### Electrical Parameters

Light Beads:	1515
LED Qty:	216pcs/m
Width:	2.6mm
Voltage:	DC12/24V
Power:	4.8W/M
CRI:	93
LM/M:	532
Color:	3000K/4000K/6500K



### Cut size

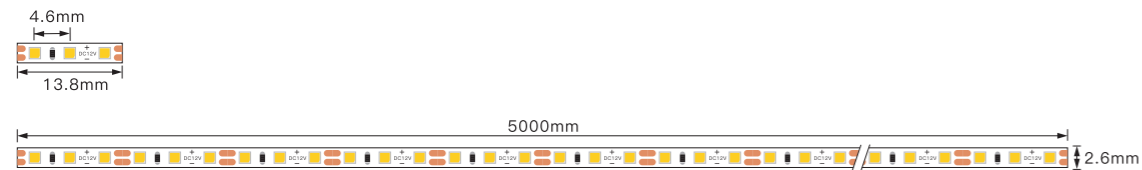

## NW-2025-120-3mm

### Feature

1. SMD 2025 LED, RA>90
2. Every LED can be cut
3. Narrow FPCB width:3mm
4. Suitable for very small size profile



### Electrical Parameters

Light Beads:	2025
LED Qty:	120pcs/m
Width:	3mm
Voltage:	DC12/24V
Power:	7.2W/M
CRI:	90/95
LM/M:	697
Color:	3000K/4000K/6500K



### Cut size

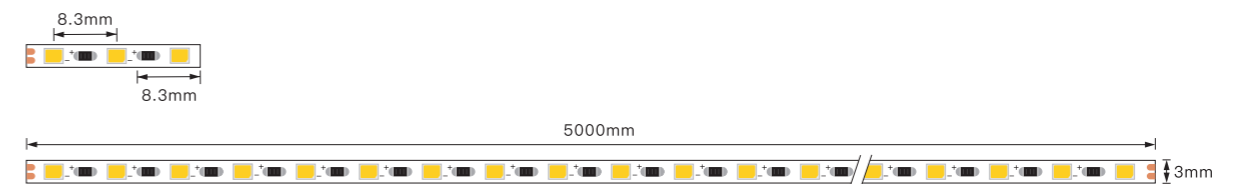

### Feature

1. SMD 2025 LED, RA>90
2. Stable and low light decay, reliability
3. Narrow FPCB width:3mm
4. Suitable for very small size profile



### Electrical Parameters

Light Beads:	2025
LED Qty:	168pcs/m
Width:	3mm
Voltage:	DC12V
Power:	6.3W/M
CRI:	90/95
LM/M:	710
Color:	3000K/4000K/6500K



### Cut size

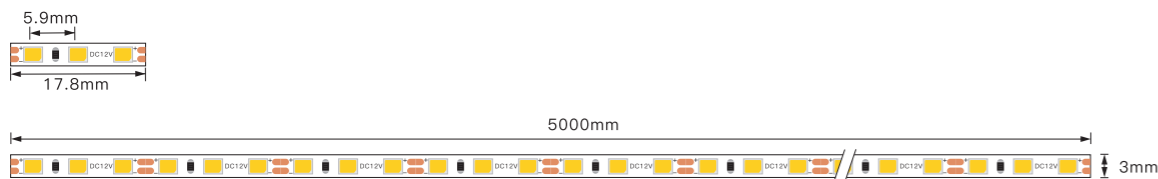

### Feature

1. SMD 2025 LED, RA>90
2. Stable and low light decay, reliability
3. Narrow FPCB width:3mm
4. Suitable for very small size profile



### Electrical Parameters

Light Beads:	2025
LED Qty:	192pcs/m
Width:	3mm
Voltage:	DC12V
Power:	7.6W/M
CRI:	90/95
LM/M:	830
Color:	3000K/4000K/6500K



### Cut size

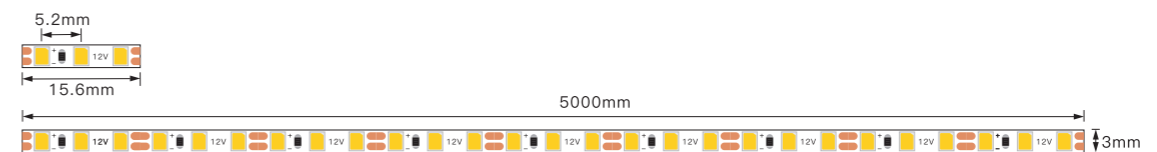

## Feature

1. SMD 2216 LED, RA>90
2. Stable and low light decay, reliability
3. Narrow FPCB width:3mm
4. Suitable for very small size profile



## Electrical Parameters

Light Beads:	2216
LED Qty:	240pcs/m
Width:	3mm
Voltage:	DC12V
Power:	7W/M
CRI:	90/95
LM/M:	790
Color:	3000K/4000K/6500K



## Cut size

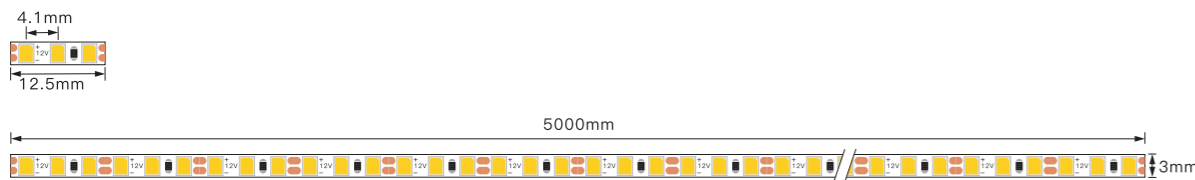

## Feature

1. SMD 2025 LED, RA>90
2. Stable and low light decay, reliability
3. Narrow FPCB width:3mm
4. Suitable for very small size profile

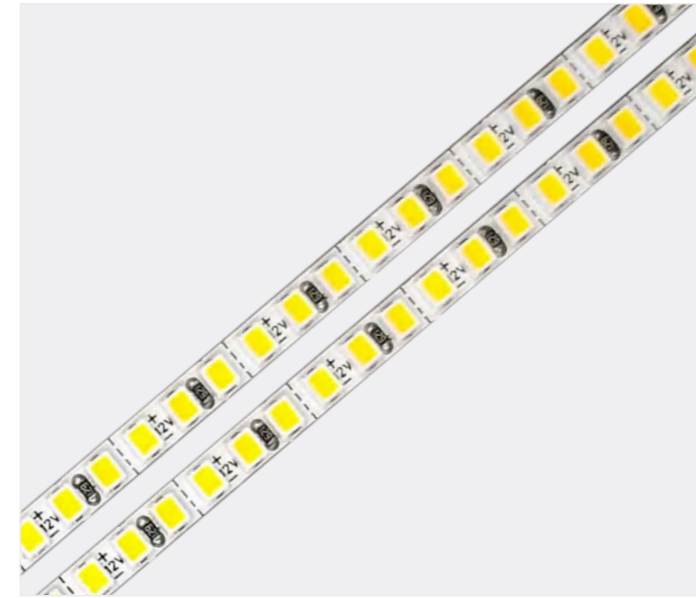

## Electrical Parameters

Light Beads:	2025
LED Qty:	300pcs/m
Width:	3mm
Voltage:	DC12V
Power:	7.2W/M
CRI:	90/95
LM/M:	880
Color:	3000K/4000K/6500K



## Cut size

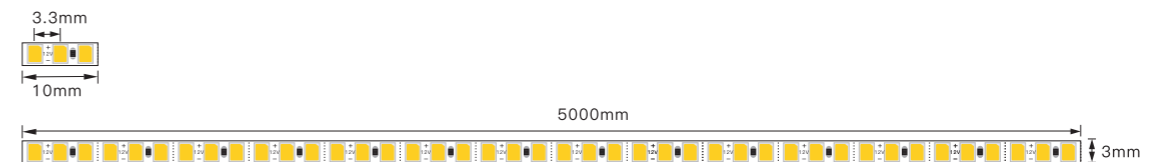

# NW-2835-120-4mm-3G

## Feature

1. Narrow FPCB width: 4mm
2. Double layer 2 oz copper PCB for good heat dissipation
3. Operate longer life and better for energy saving
4. Suitable for small size profile



## Electrical Parameters

Light Beads:	2835
LED Qty:	120pcs/m
Width:	4mm
Voltage:	DC12V
Power:	6W/M
CRI:	90/95
LM/M:	720
Color:	3000K/4000K/6500K



## Cut size

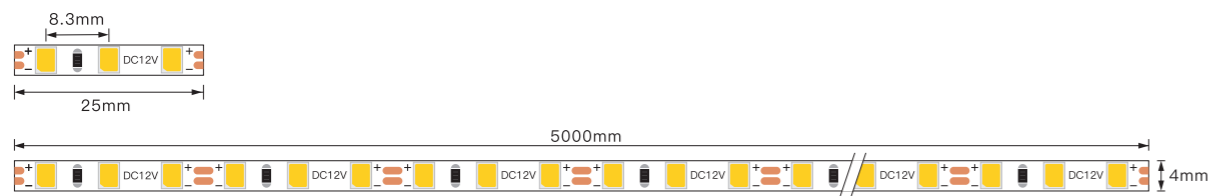

# NW-2835-120-4mm-24V-4G

## Feature

1. Narrow FPCB width: 4mm
2. With 24V voltage and cut with 4LED
3. Operate longer life and better for energy saving
4. Suitable for small size profile

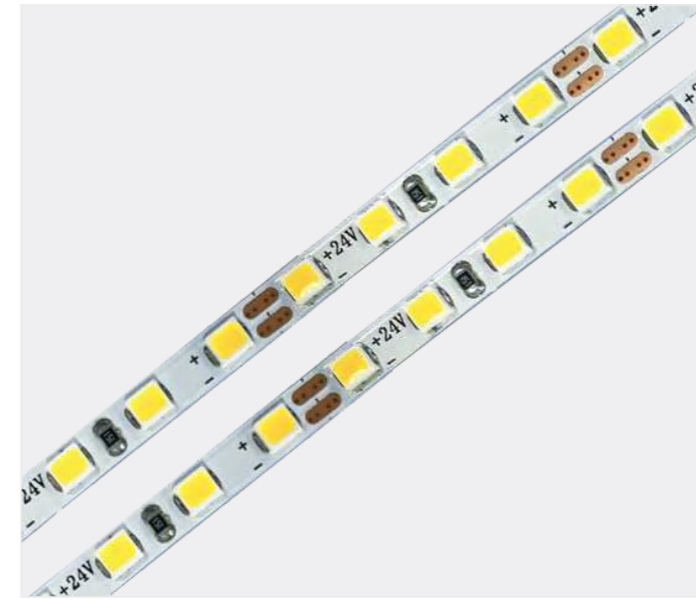

## Electrical Parameters

Light Beads:	2835
LED Qty:	120pcs/m
Width:	4mm
Voltage:	DC24V
Power:	9.6W/M
CRI:	90
LM/M:	720
Color:	3000K/4000K/6500K



## Cut size

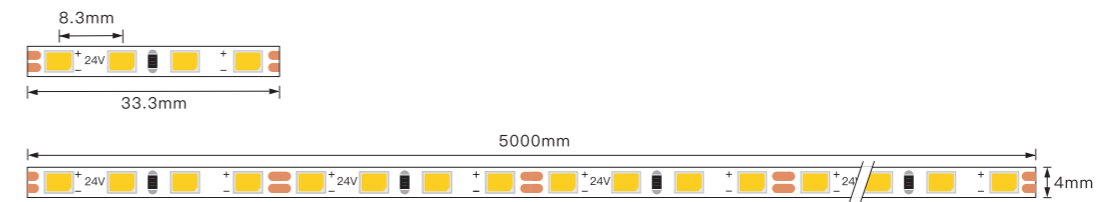

# CCT Tunabel LED Strip



Tunable LED strip lights allow you to control the color temperature and easily control the strip light's output

## CCT-2835-120-5mm-2Wire

### Feature

1. SMD 2835 CCT 2 colors in 1 leds (Warm White & White)
2. Adjustable CCT & brightness with dimming controls
3. Stable and Low light decay, reliability
4. More uniform lighting
5. With 2 wire

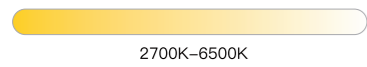

### Electrical Parameters

Light Beads:	2835
LED Qty:	120pcs/m
Width:	5mm
Voltage:	DC12V
Power:	9.6W/M
CRI:	90
LM/M:	750
Color:	2700-6500K



### Cut size

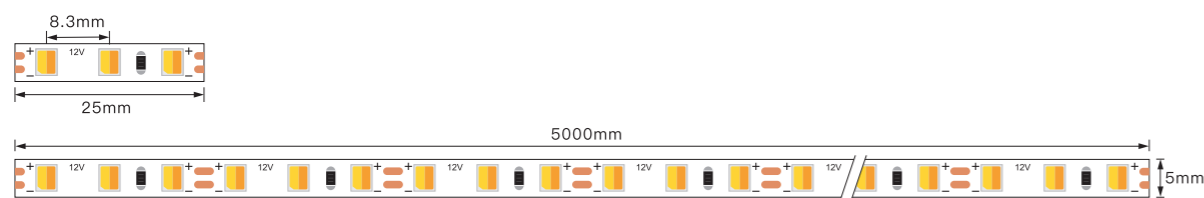

## CCT-2835-168-5mm-2Wire

### Feature

1. SMD 2835 CCT 2 colors in 1 leds (Warm White & White)
2. Adjustable CCT & brightness with dimming controls
3. Stable and Low light decay, reliability
4. More uniform lighting
5. Only with 2 wires

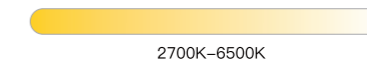
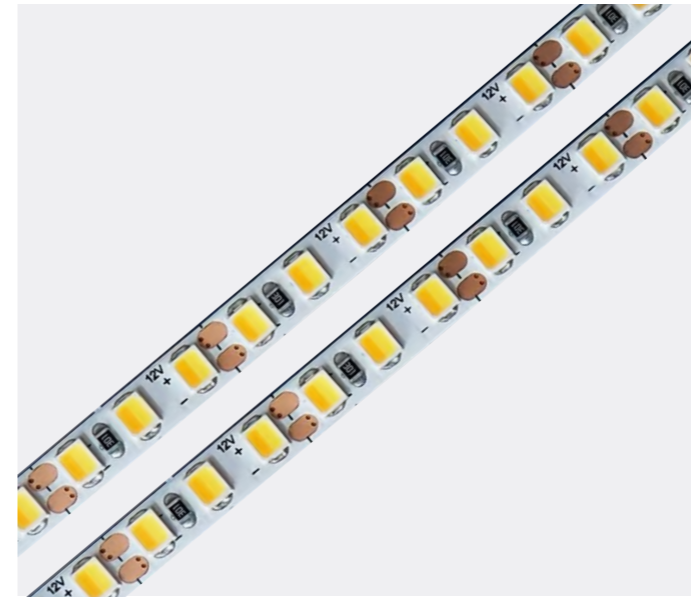

### Electrical Parameters

Light Beads:	2835
LED Qty:	168pcs/m
Width:	5mm
Voltage:	DC12V
Power:	10W/M
CRI:	90
LM/M:	810
Color:	2700-6500K



### Cut size



## CCT-CF-2835-120-5mm-2Wire

### Feature

1. Cut free design
2. SMD 2835 CCT 2 colors in 1 LED (Warm White & White)
3. Adjustable CCT & brightness with dimming controls
4. Stable and Low light decay, reliability
5. With 2 /3wires

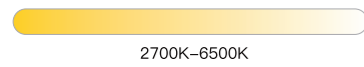
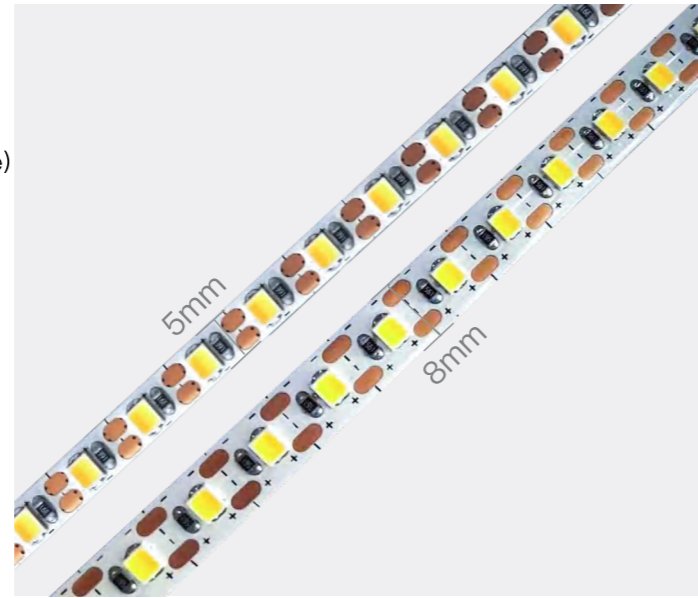

### Electrical Parameters

Light Beads:	2835
LED Qty:	120pcs/m
Width:	5/8mm
Voltage:	DC12V
Power:	7.5W/M
CRI:	90
LM/M:	760
Color:	2700-6500K



### Cut size

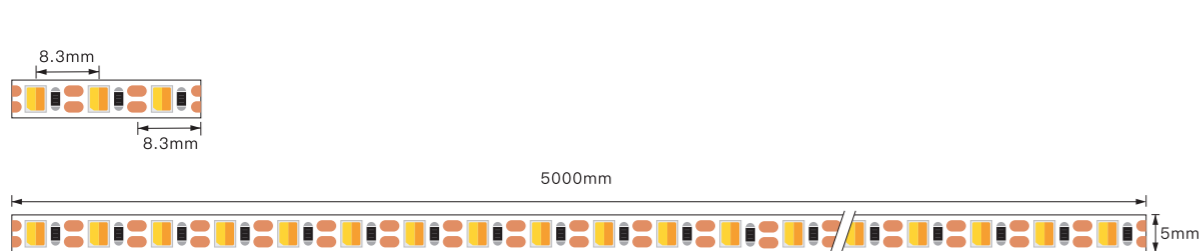

## CCT-2835-120-8mm-2Wire

### Feature

1. SMD 2835 CCT 2 colors in 1 leds (Warm White & White)
2. Adjustable CCT & brightness with dimming controls
3. Stable and Low light decay, reliability
4. More uniform lighting
5. With 2 wire

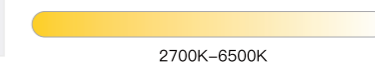
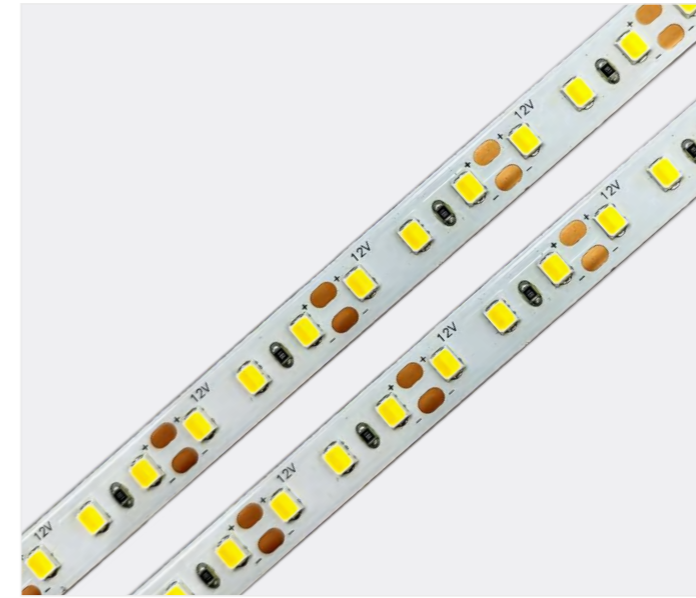

### Electrical Parameters

Light Beads:	2835
LED Qty:	120pcs/m
Width:	8mm
Voltage:	DC12V
Power:	9.6W/M
CRI:	90
LM/M:	760
Color:	2700-6500K



### Cut size

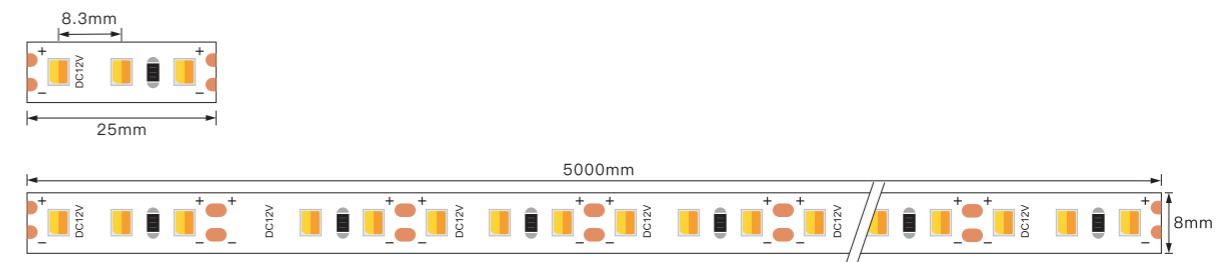

## CCT-2835-120-5mm-3Wire

### Feature

1. SMD 2835 CCT 2 colors in 1 leds (Warm White & White)
2. Adjustable CCT & brightness with dimming controls
3. Stable and Low light decay, reliability
4. More uniform lighting
5. With 3 wire

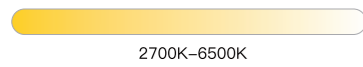
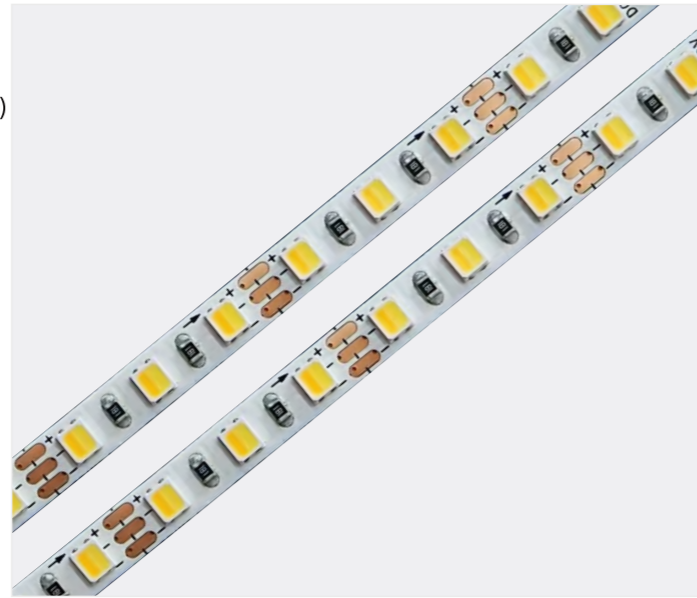

### Electrical Parameters

Light Beads:	2835
LED Qty:	120pcs/m
Width:	5mm
Voltage:	DC12V
Power:	9.6W/M
CRI:	90
LM/M:	750
Color:	2700-6500K



### Cut size

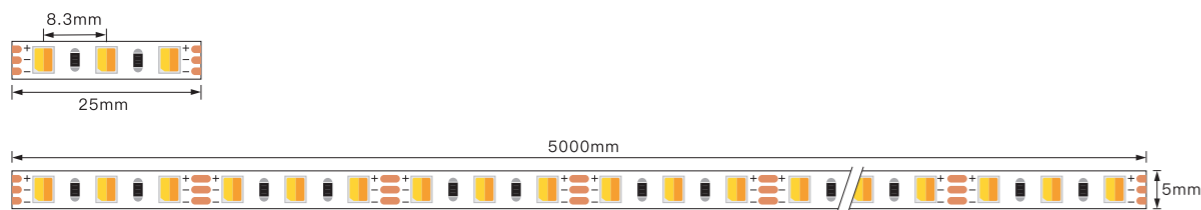

## CCT-2835-120-8mm-3Wire

### Feature

1. SMD 2835 CCT 2 colors in 1 leds (Warm White & White)
2. Adjustable CCT & brightness with dimming controls
3. Stable and Low light decay, reliability
4. More uniform lighting
5. With 3 wire

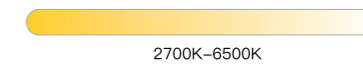
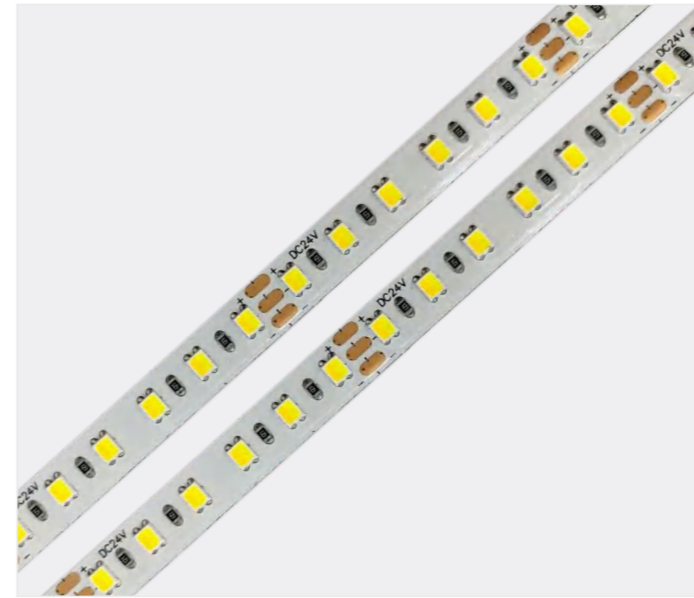

### Electrical Parameters

Light Beads:	2835
LED Qty:	120pcs/m
Width:	8mm
Voltage:	DC12V
Power:	9.6W/M
CRI:	90
LM/M:	760
Color:	2700-6500K



### Cut size

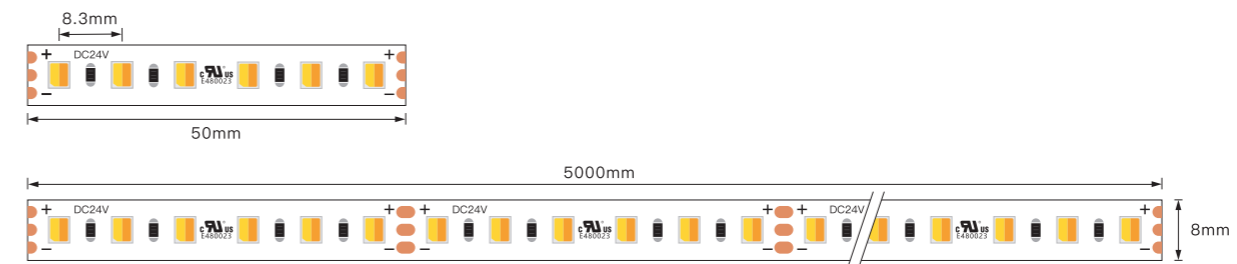

## CCT-2835-120-8mm-3Wire(60+60)

### Feature

1. Made by dual 2835 Top LED (Warm White & White)
2. Adjustable CCT & brightness with dimming controls
3. Stable and Low light decay, reliability

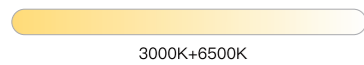
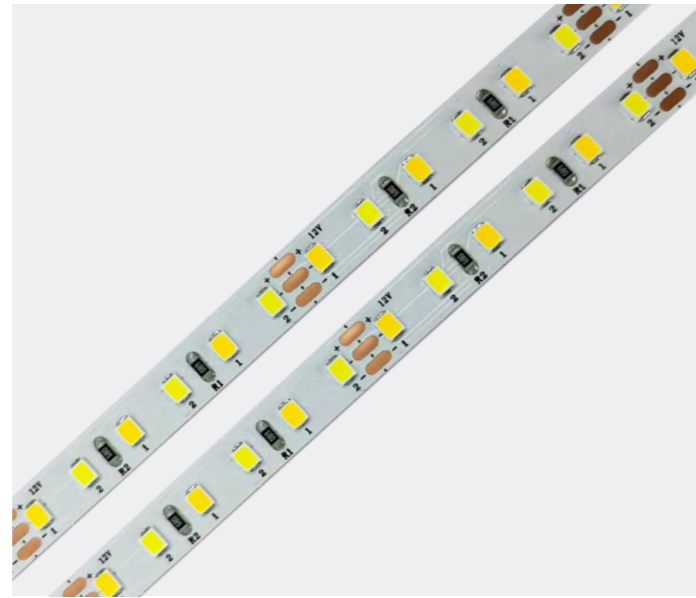

### Electrical Parameters

Light Beads:	2835
LED Qty:	120pcs/m
Width:	8mm
Voltage:	DC12V
Power:	9.6W/M
CRI:	90
LM/M:	750
Color:	3000+6500K



### Cut size



## CCT-2835-240-10mm-D

### Feature

1. Made by dual 2835 Top LEDs (Warm White & White)
2. Adjustable CCT & brightness with dimming controls
3. Double row with 240LED
4. Stable and Low light decay, reliability
5. Excellent color rendering, RA > 90

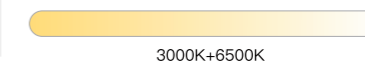
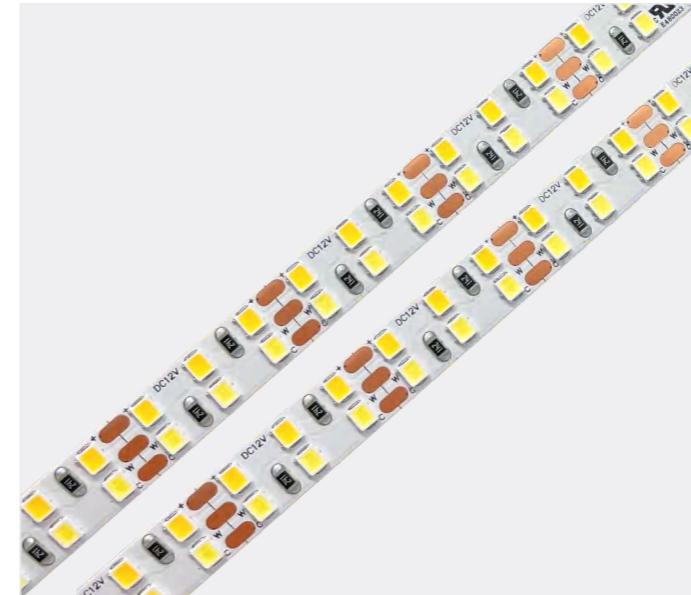

### Electrical Parameters

Light Beads:	2835
LED Qty:	240pcs/m
Width:	10mm
Voltage:	DC12V/24V
Power:	14W/M
CRI:	90
LM/M:	1500
Color:	3000K+6500K



### Cut size

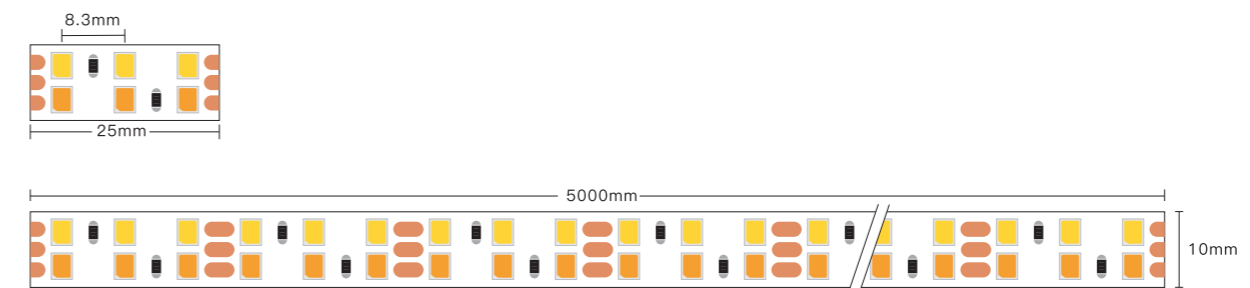

# Cut Free LED Strip



- Cut free design
- Can be used well with aluminum profile
- It is a good product for furniture, rooms, hotels, cabinets and ceilings, etc.

# CF-2835-120-5mm

## Feature

- 1. SMD 2835 LED, RA>90
- 2. Every LED can be cut
- 3. Stable and low light decay

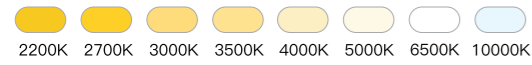
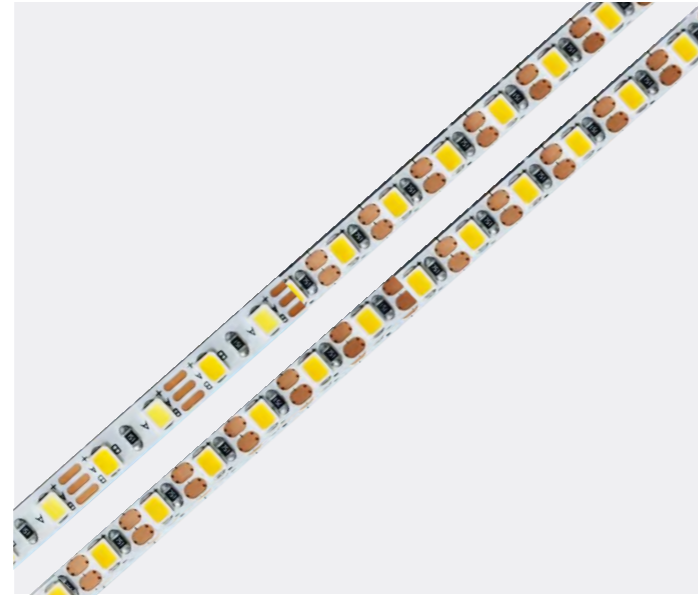

## Electrical Parameters

Light Beads:	2835
LED Qty:	120pcs/m
Width:	5mm
Voltage:	DC12/24V
Power:	6.5W/M
CRI:	90
LM/M:	650
Color:	3000K/4000K/6500K



## Cut size

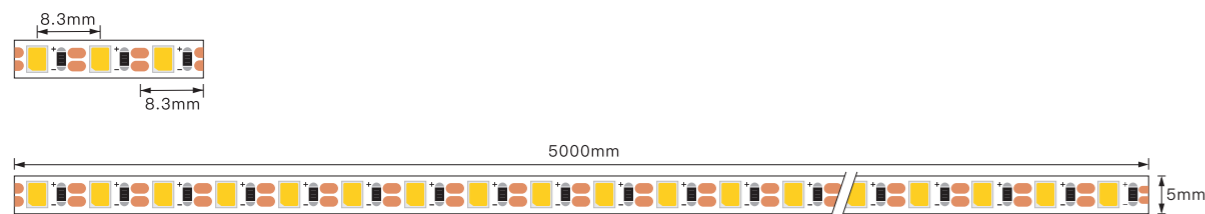

# CF-2016-136-5mm

## Feature

- 1. SMD 2016 LED, RA>90
- 2. Good product for cabinet
- 3. Double layer 2 oz copper PCB for good heat dissipation

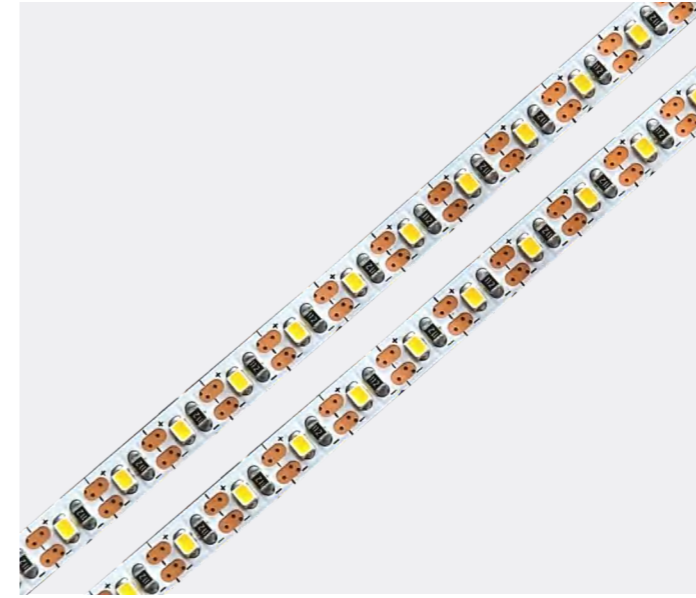

## Electrical Parameters

Light Beads:	2016
LED Qty:	136pcs/m
Width:	5mm
Voltage:	DC12V
Power:	6.5W/M
CRI:	90
LM/M:	580
Color:	3000K/4000K/6500K



## Cut size

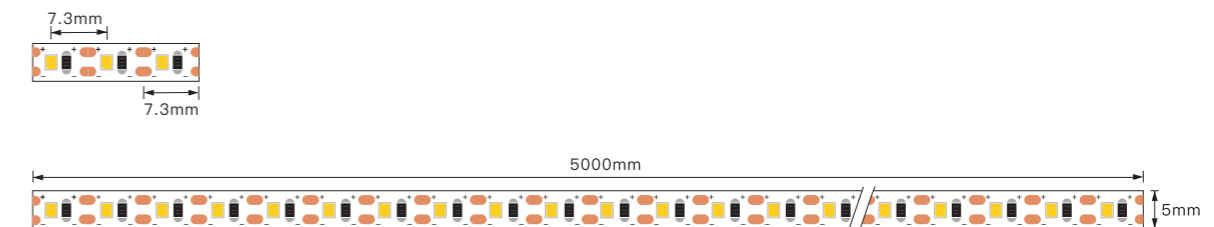

## CF-2835-144-5mm

### Feature

1. SMD 2835 LED, RA>90
2. Every LED can be cut
3. Stable and low light decay

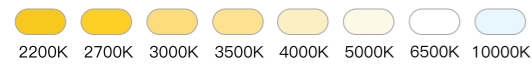

### Electrical Parameters

Light Beads:	2835
LED Qty:	144pcs/m
Width:	5mm
Voltage:	DC12V
Power:	9.3W/M
CRI:	92
LM/M:	739
Color:	3000K/4000K/6500K



### Cut size

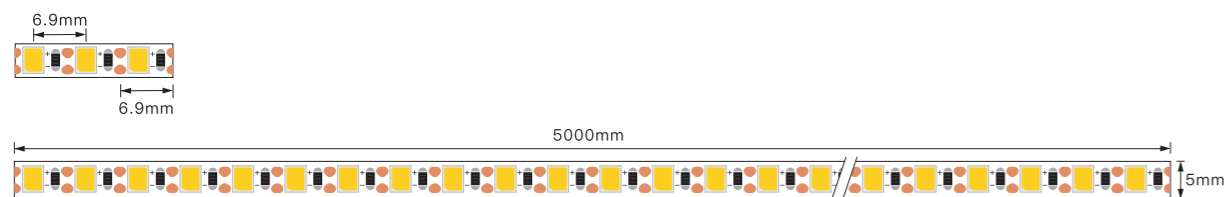

## CF-2025-168-5mm

### Feature

1. SMD 2025 LED, RA>90
2. Every LED can be cut
3. Stable and low light decay
4. Double layer 2 oz copper PCB for good heat dissipation
5. Longer operation life and better energy efficiency

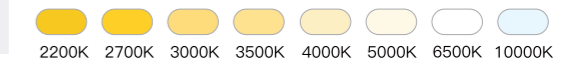
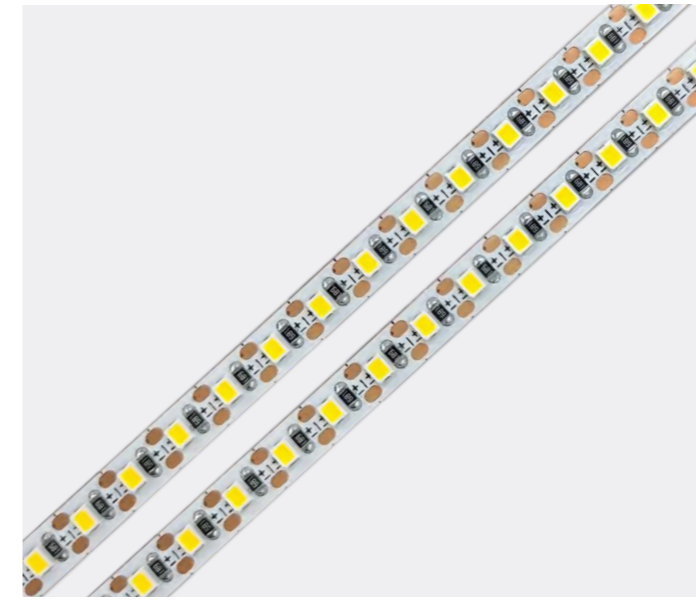

### Electrical Parameters

Light Beads:	2025
LED Qty:	168pcs/m
Width:	5mm
Voltage:	DC12V
Power:	9.6W/M
CRI:	90
LM/M:	660
Color:	3000K/4000K/6500K



### Cut size

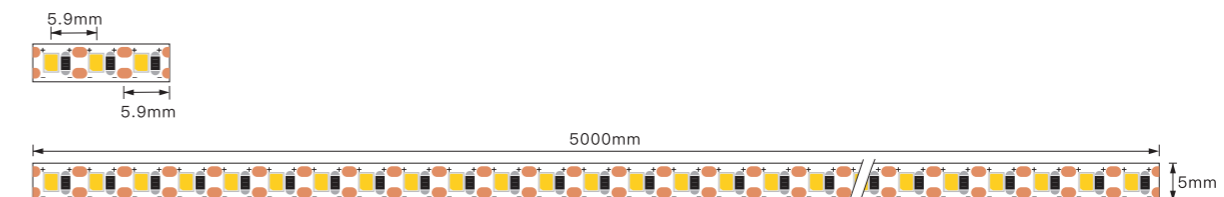

## Feature

1. Cut free
2. SMD 2025 LED, RA>90
3. Stable and low light decay
4. Longer operation life and better energy efficiency
5. Suitable for cabinet/mirror/furniture

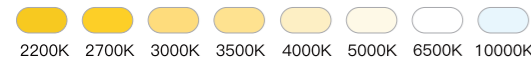
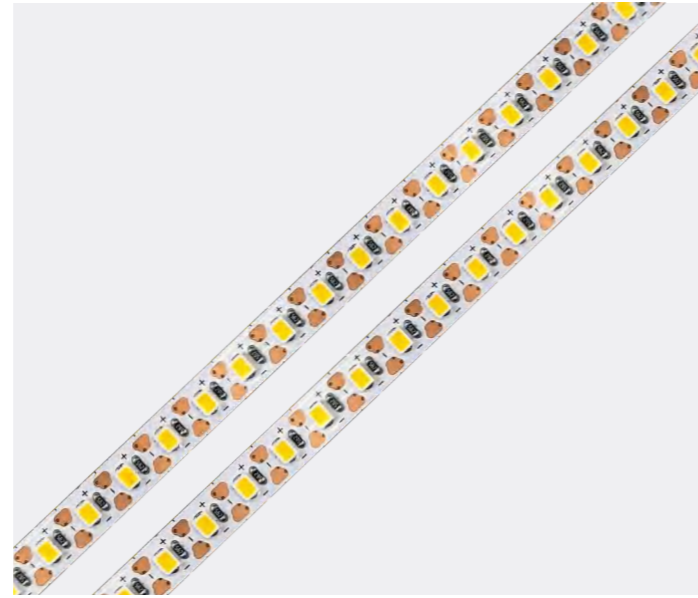

## Electrical Parameters

Light Beads:	2025
LED Qty:	180pcs/m
Width:	5mm
Voltage:	DC12/24V
Power:	6.8W/M
CRI:	93
LM/M:	731
Color:	3000K/4000K/6500K



## Cut size

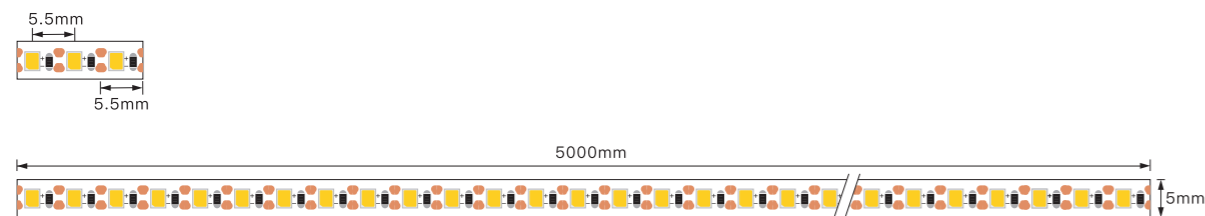

## Feature

1. Cut free
2. SMD 2835 LED, RA>90
3. Stable and low light decay
4. Longer operation life and better energy efficiency
5. Suitable for cabinet/mirror/furniture

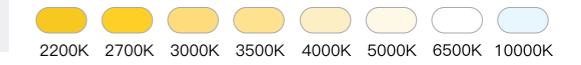
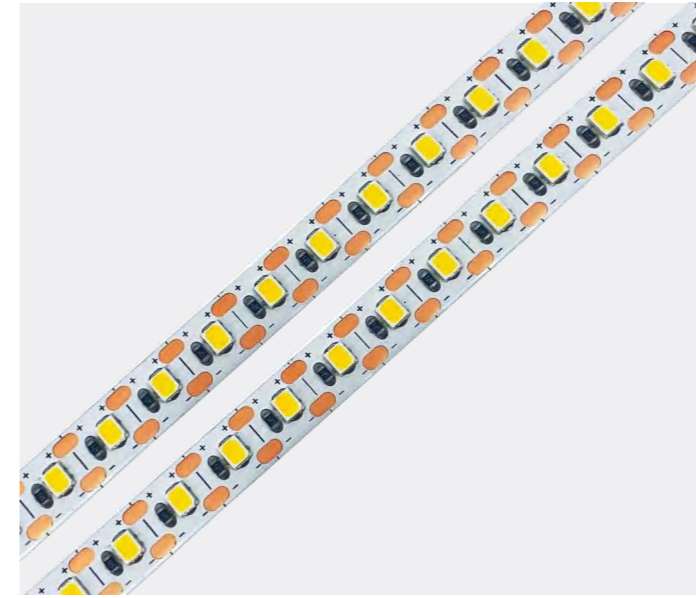

## Electrical Parameters

Light Beads:	2835
LED Qty:	120pcs/m
Width:	8mm
Voltage:	DC12/24V
Power:	8.5W/M
CRI:	90
LM/M:	760
Color:	3000K/4000K/6500K



## Cut size

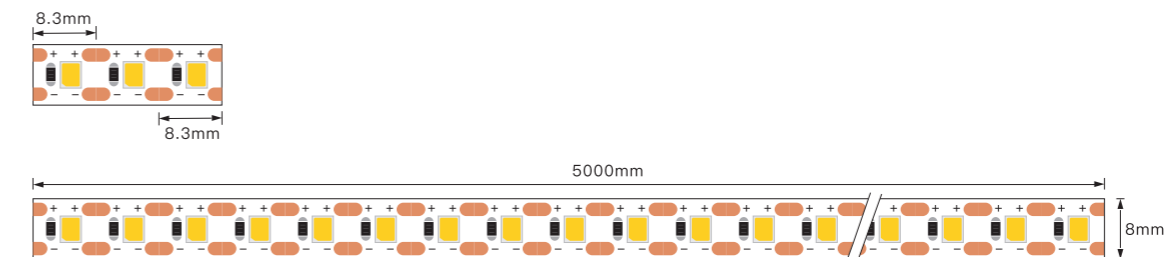



## Soldering Free LED Strip

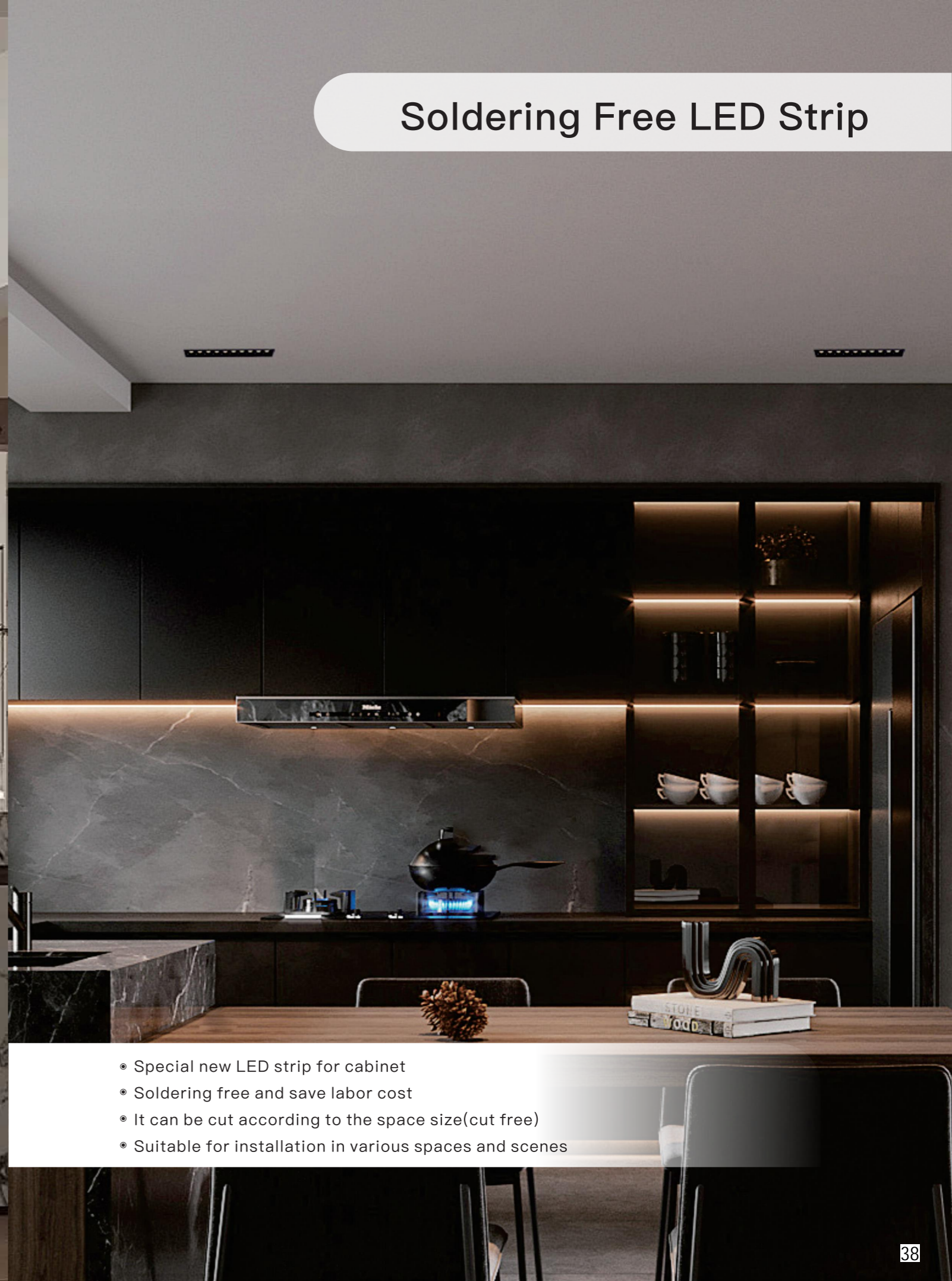

- Special new LED strip for cabinet
- Soldering free and save labor cost
- It can be cut according to the space size(cut free)
- Suitable for installation in various spaces and scenes

## SF-2025-120-5mm

### Feature

1. Every led is cut free design and without waste
2. Excellent color rendering, RA>90
3. Stable and Low light decay
4. Special new led strip for cabinet

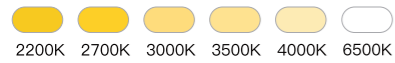

### Electrical Parameters

Light Beads:	2025
LED Qty:	120pcs/m
Width:	5mm
Voltage:	DC12V
Power:	6W/M
CRI:	90
LM/M:	510
Color:	3000K/4000K/6500K



### Cut size

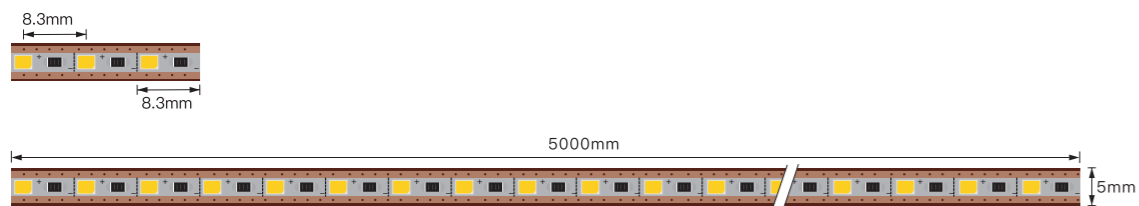

## SF-2025-120-6.5mm

### Feature

1. Gold-plated PCB to prevent oxidation
2. Every led cut free design
3. Excellent color rendering, RA>90
4. Special NEW led strip for cabinet



### Electrical Parameters

Light Beads:	2025
LED Qty:	150pcs/m
Width:	6.5mm
Voltage:	DC12V
Power:	7.5W/M
CRI:	90
LM/M:	635
Color:	3000K/4000K/6500K



### Cut size

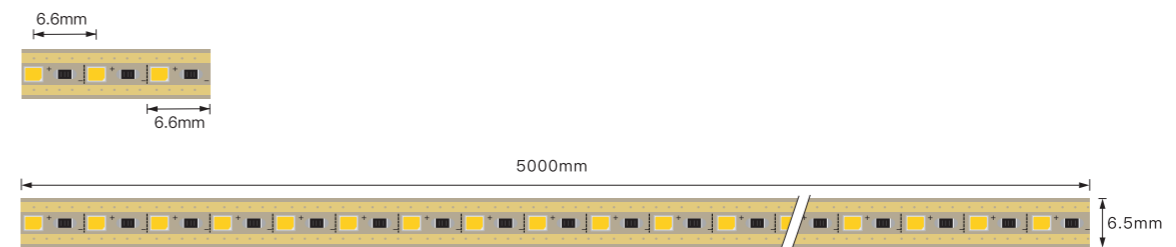

# Cabinet LED Linear Light

## Feature

1. Work with quick connector instead of solder wires, save time and cost
2. Cut free
3. Excellent color rendering up to Ra90
4. This design is to make the installation more convenient
5. Mainly used for cabinet



## Electrical Parameters

Light Beads:	2025
LED Qty:	150pcs/m
Width:	6.8mm
Voltage:	DC12V
Power:	7.5W/M
CRI:	90
LM/M:	635
Color:	3000K/4000K/6500K



## Cut size

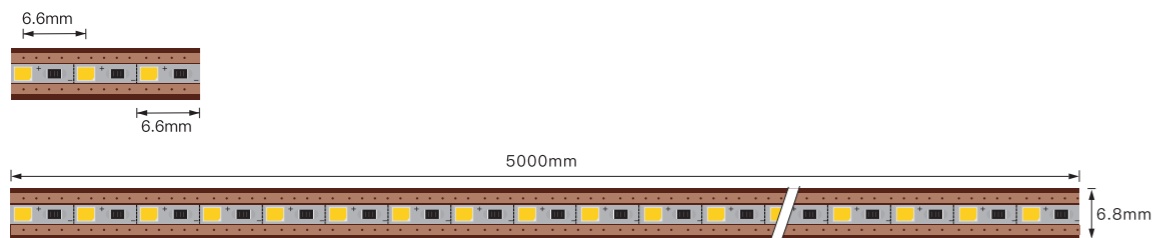

# SF-2835-204-6.8mm

## Feature

1. 2835 204LED/M with more brightness
2. Cut free
3. Excellent color rendering, RA>90
4. Special NEW led strip for cabinet



## Electrical Parameters

Light Beads:	2835
LED Qty:	204pcs/m
Width:	6.8mm
Voltage:	DC12V
Power:	7.5W/M
CRI:	90
LM/M:	660
Color:	3000K/4000K/6500K



## Cut size

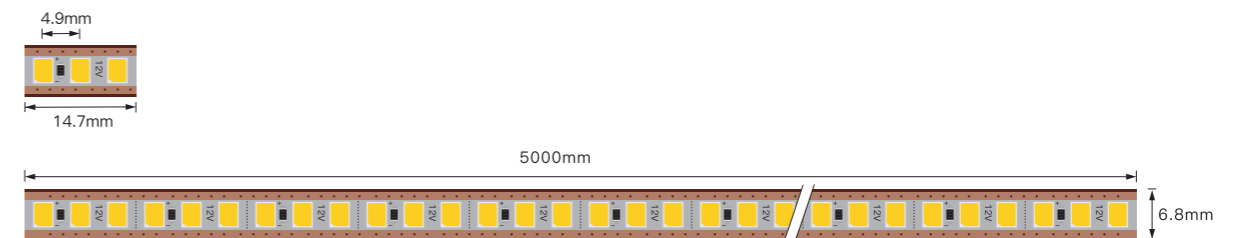

## Feature

1. Every led is cut free design and without waste
2. Excellent color rendering, RA>90
3. Stable and Low light decay
4. Special new led strip for cabinet

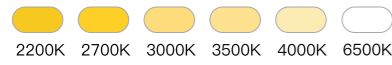

## Electrical Parameters

Light Beads:	2025
LED Qty:	120pcs/m
Width:	8mm
Voltage:	DC12V
Power:	7.5W/M
CRI:	90
LM/M:	530
Color:	3000K/4000K/6500K



## Cut size

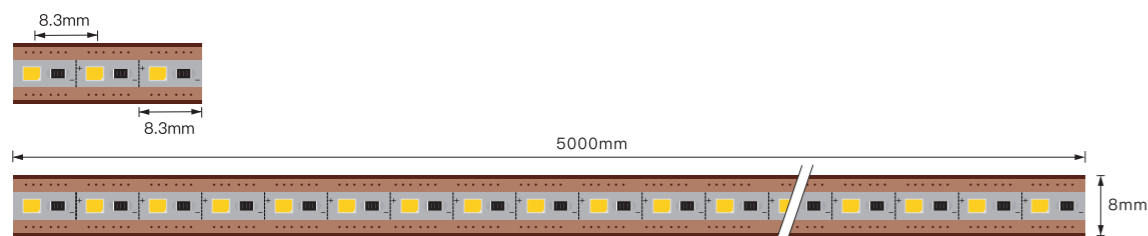

## Feature

1. 2835 150LED/M with more brightness
2. Cut free design
3. Excellent color rendering, RA>90
4. Special NEW led strip for cabinet

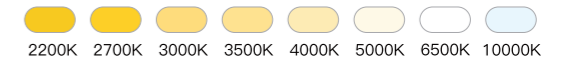

## Electrical Parameters

Light Beads:	2835
LED Qty:	150pcs/m
Width:	8mm
Voltage:	DC12V
Power:	7.5W/M
CRI:	90
LM/M:	630
Color:	3000K/4000K/6500K



## Cut size

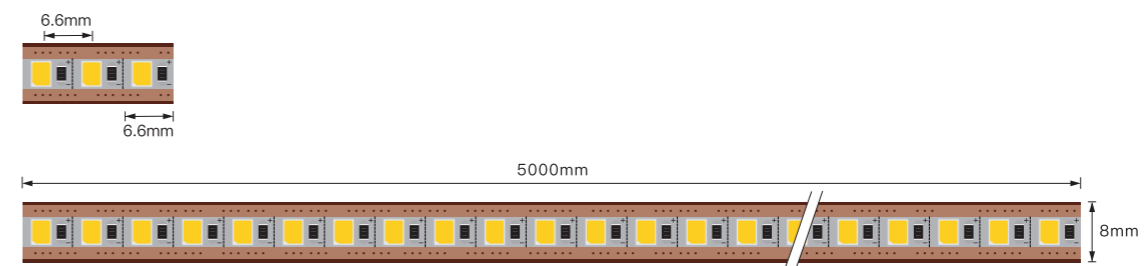



- LED strips can be used as a supplement to indoor lighting to increase ambient light, especially when soft or specific area lighting is required
- LED strips are designed to be soft and cuttable, and can be installed in various positions as needed
- It is a good product for furniture, rooms, hotels, cabinets and ceilings, etc.

## RG-2216-240-4mm

### Feature

1. Narrow FPCB width: 4mm
2. With 24V voltage and cut with 6LED
3. Operate longer life and better for energy saving
4. 240LED/M with uniform light
5. Suitable for small size profile



### Electrical Parameters

Light Beads:	2216
LED Qty:	240pcs/m
Width:	4mm
Voltage:	DC24V
Power:	9.2W/M
CRI:	95
LM/M:	930
Color:	3000K/4000K/6500K



### Cut size

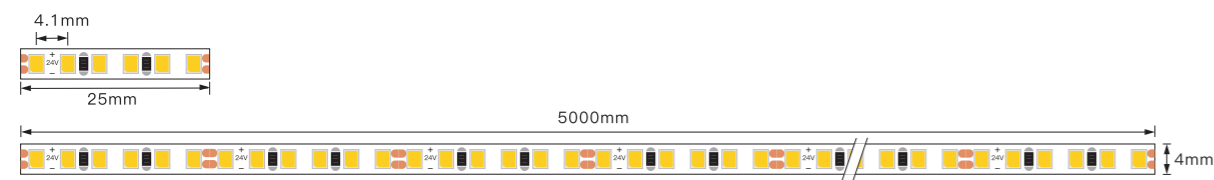

## RG-2835-120-5mm

### Feature

1. Narrow FPCB width: 5mm
2. Stable and low light decay
3. Operate longer life and better for energy saving



### Electrical Parameters

Light Beads:	2835
LED Qty:	120pcs/m
Width:	5mm
Voltage:	DC12V
Power:	5.7/7.2/9.6W/M
CRI:	90/95
LM/M:	888
Color:	3000K/4000K/6500K



### Cut size

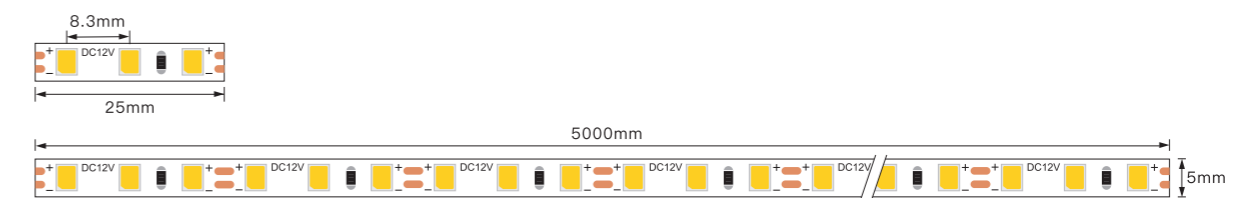

## RG-2835-136-5mm

### Feature

1. Small cut with 2LED/group and 136LED/M
2. SMD 2835 LED, RA>90
3. Narrow FPCB width:5mm
4. Achieving higher luminous output per unit power consumption



### Electrical Parameters

Light Beads:	2835
LED Qty:	136pcs/m
Width:	5mm
Voltage:	24V
Power:	3.4W/m
CRI:	90
LM/m:	401
Color:	3000K/4000K/6500K



### Cut size

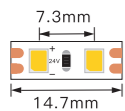

## RG-2835-168-5mm

### Feature

1. High brightness with 2835 led, Copper bracket
2. RA>80 Or RA>90
3. Stable and low light decay
4. Double layer 2 oz copper PCB for good heat dissipation
5. Longer operation life and better energy efficiency

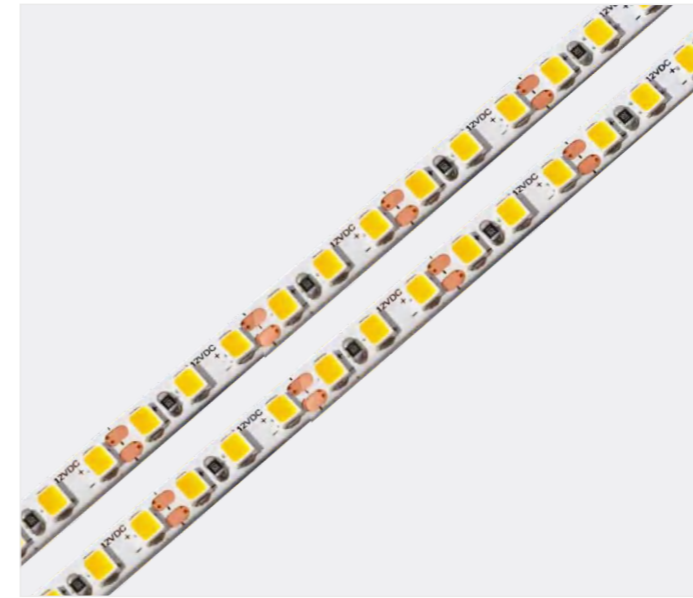

### Electrical Parameters

Light Beads:	2835
LED Qty:	168pcs/m
Width:	5mm
Voltage:	DC12V
Power:	5W/M
CRI:	80/90
LM/M:	590
Color:	3000K/4000K/6500K



### Cut size

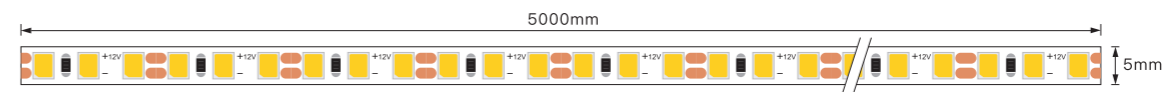
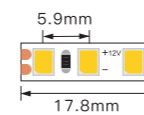

## RG-2835-180-5mm

### Feature

1. Small cut with 2LED/group and 180LED/M
2. Excellent color rendering, RA>95 or 97
3. Good product for small size cabinet linear light

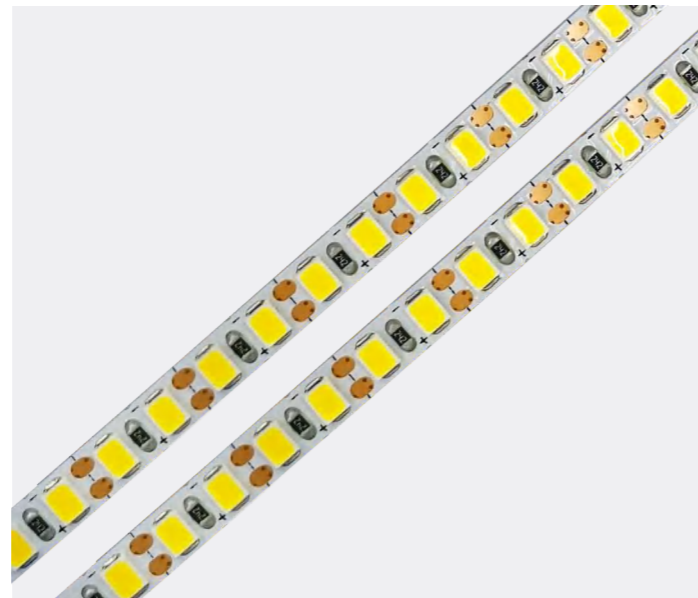

### Electrical Parameters

Light Beads:	2835
LED Qty:	180pcs/m
Width:	5mm
Voltage:	DC24V
Power:	7.5W/M
CRI:	95/97
LM/M:	686
Color:	3000K/4000K/6500K



### Cut size

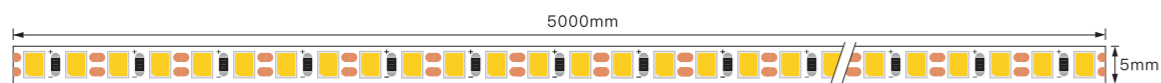
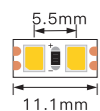

## RG-2025-240-5mm

### Feature

1. 2025 240LED/M with uniform light
2. Good product for small size cabinet linear light
3. Excellent color rendering, RA>90
4. 12V or 24v are available

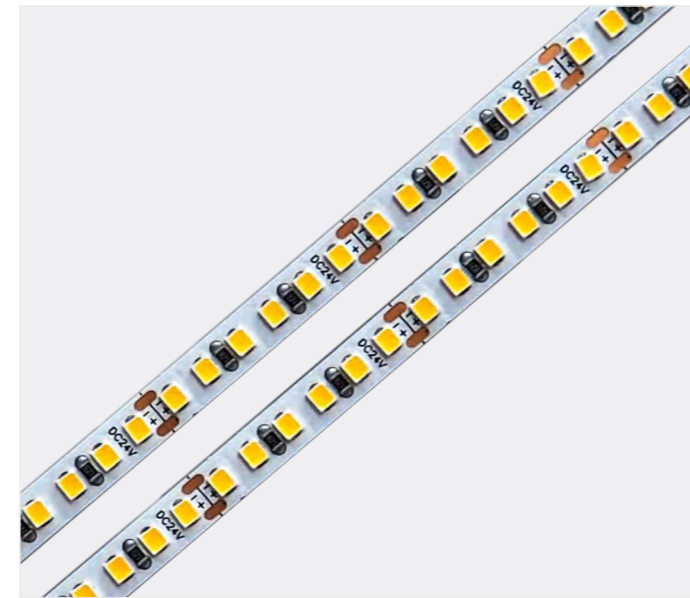

### Electrical Parameters

Light Beads:	2025
LED Qty:	240pcs/m
Width:	5mm
Voltage:	DC24V
Power:	6.5W/M
CRI:	90
LM/M:	550
Color:	3000K/4000K/6500K



### Cut size

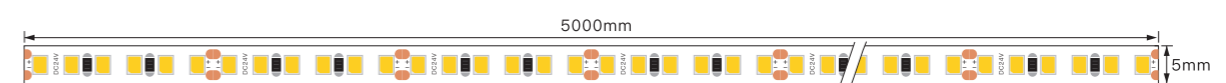
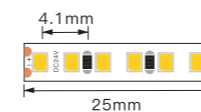

Feature

- 1. Narrow FPCB width:5mm
- 2. Stable and low light decay
- 3. Operate longer life and better for energy saving

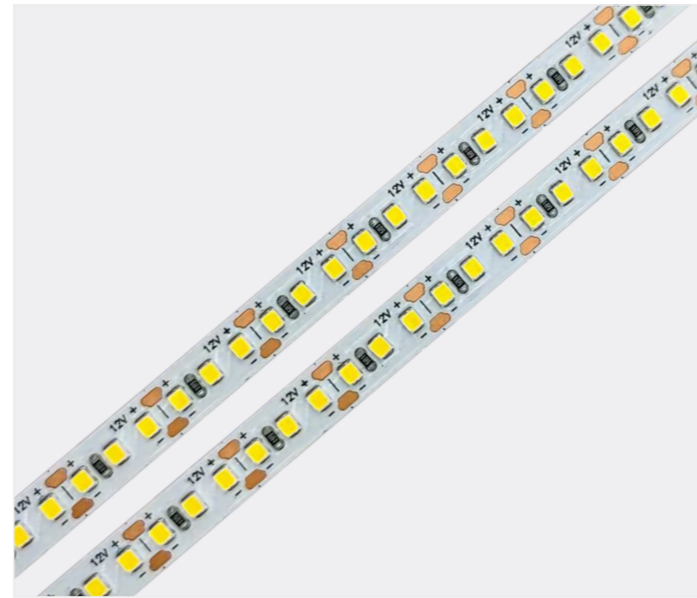

Electrical Parameters

Light Beads:	1515
LED Qty:	300pcs/m
Width:	5mm
Voltage:	DC12V
Power:	5W/m
CRI:	90/95
LM/M:	763
Color:	3000K/4000K/6500K



Cut size

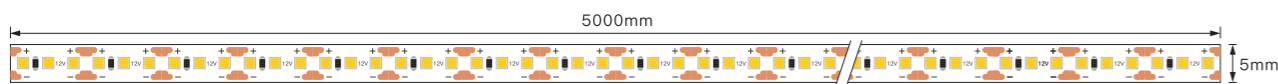
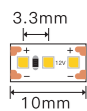

Feature

- 1. Narrow FPCB width:5mm
- 2. Stable and low light decay
- 3. Operate longer life and better for energy saving

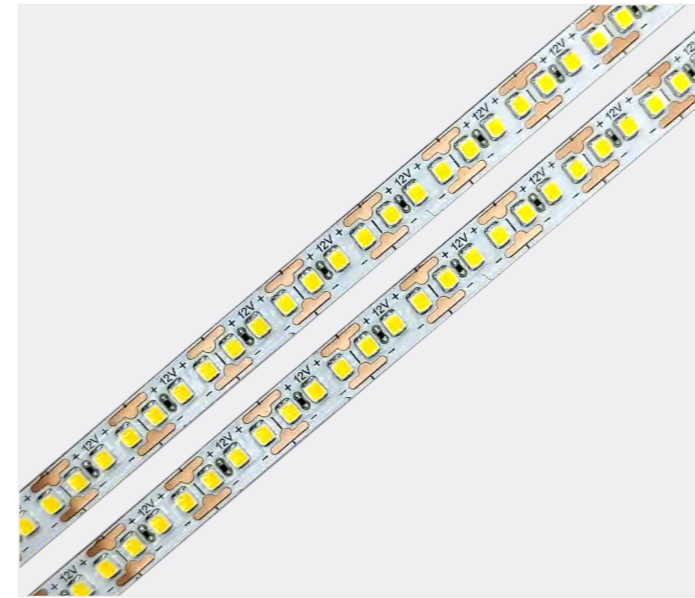

Electrical Parameters

Light Beads:	1515
LED Qty:	348pcs/m
Width:	5mm
Voltage:	DC12V
Power:	7.3W/M
CRI:	90
LM/M:	816
Color:	3000K/4000K/6500K



Cut size

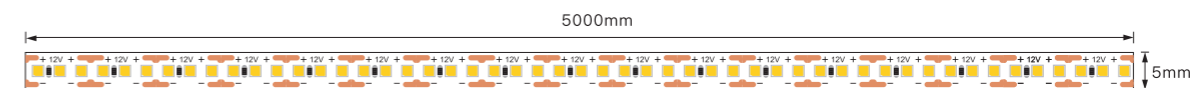

## RG-2835-60-8mm

### Feature

1. 2835LED with high brightness and copper bracket
2. Stable and low light decay
3. It can be for sign letter/furniture/decoration

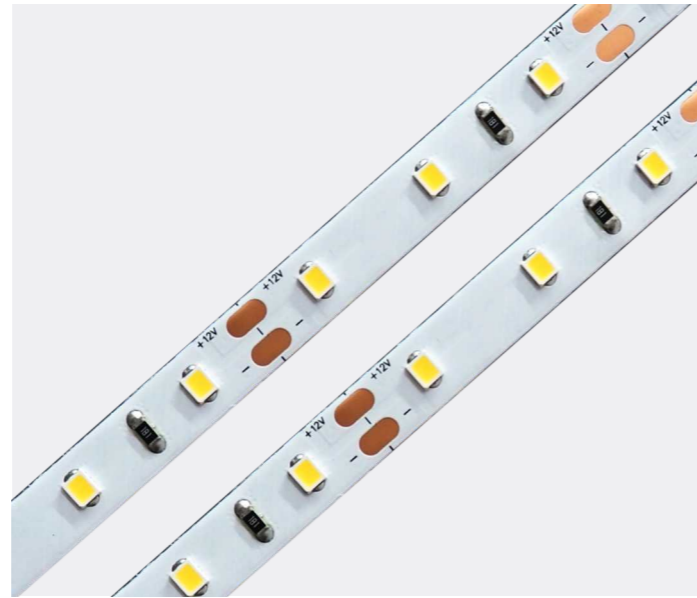

### Electrical Parameters

Light Beads:	2835
LED Qty:	60pcs/m
Width:	8mm
Voltage:	DC12V
Power:	4.8W/M
CRI:	80/90
LM/M:	660
Color:	3000K/4000K/6500K



### Cut size

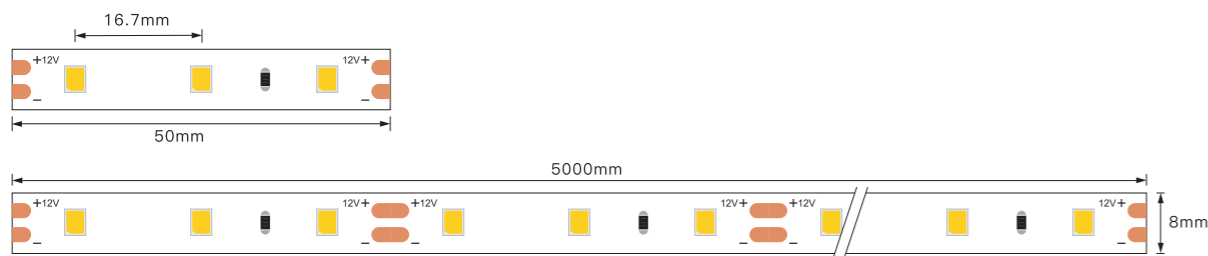

## RG-2835-120-8mm

### Feature

1. Stable and Low light decay
2. Excellent color rendering, RA>80 or 90
3. Double layer copper PCB for good heat dissipation
4. Custom wattage, 2W/6W/9.6W/12W/M

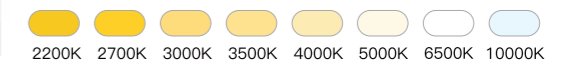

### Electrical Parameters

Light Beads:	2835
LED Qty:	120pcs/m
Width:	8mm
Voltage:	DC12V
Power:	8W/M
CRI:	90
LM/M:	905
Color:	3000K/4000K/6500K



### Cut size

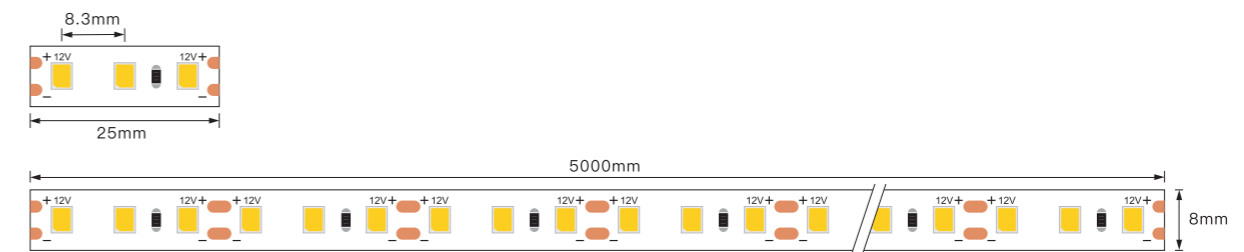

## RG-2025-280-8mm

### Feature

1. 280LED/M and 24V for project
2. Excellent color rendering, RA>90
3. Stable, low light decay with 3 OZ copper
4. Suitable for cabinet light/Celling/showcase

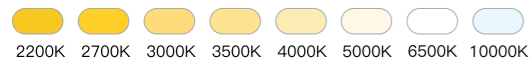
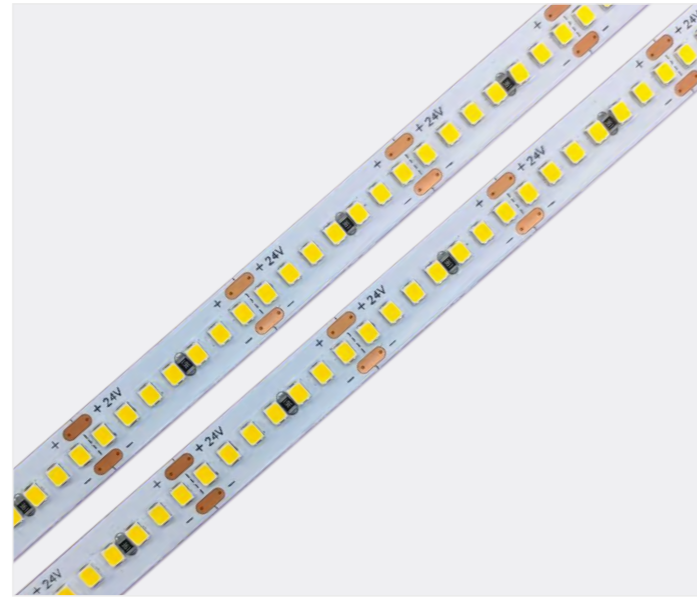

### Electrical Parameters

Light Beads:	2025
LED Qty:	280pcs/m
Width:	8mm
Voltage:	DC24V
Power:	12.8W/M
CRI:	90
LM/M:	1664
Color:	3000K/4000K/6500K



### Cut size

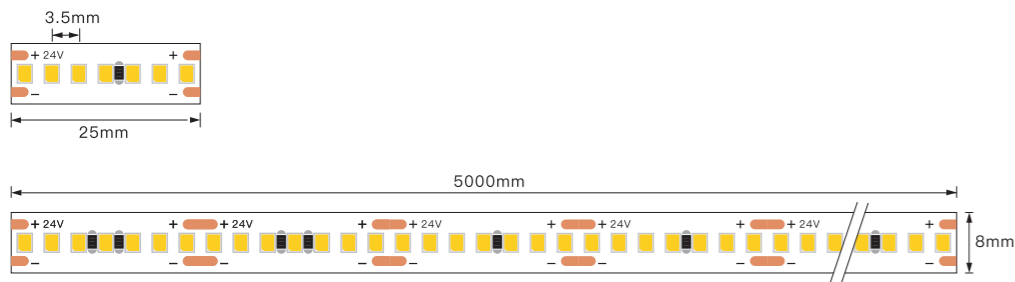

## RG-5050-60-10mm

### Feature

1. 5050 LED with high brightness and copper bracket
2. Stable and low light decay
3. It can be for sign letter/furniture/decoration



### Electrical Parameters

Light Beads:	5050
LED Qty:	60pcs/m
Width:	10mm
Voltage:	DC12V
Power:	12W/M
CRI:	90
LM/M:	1230
Color:	3000K/4000K/6500K



### Cut size

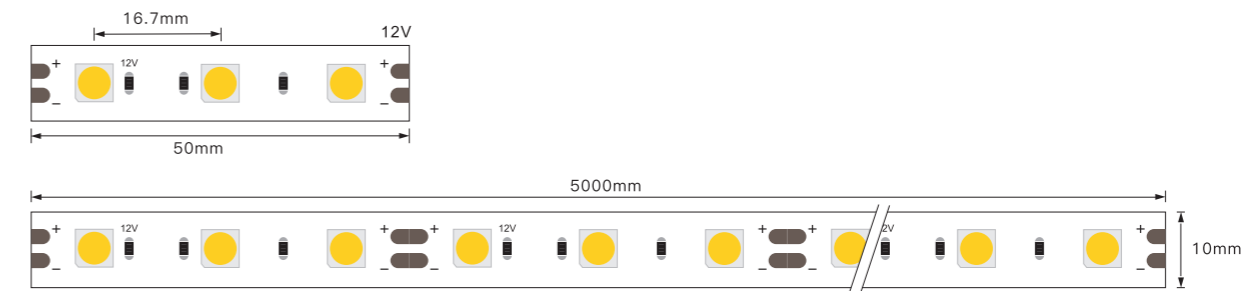

# RG-2835-180-10mm

## Feature

1. 180LED/M and 24V for project
2. Excellent color rendering, RA>90
3. Stable and low light decay
4. Suitable for cabinet light/Ceiling/showcase

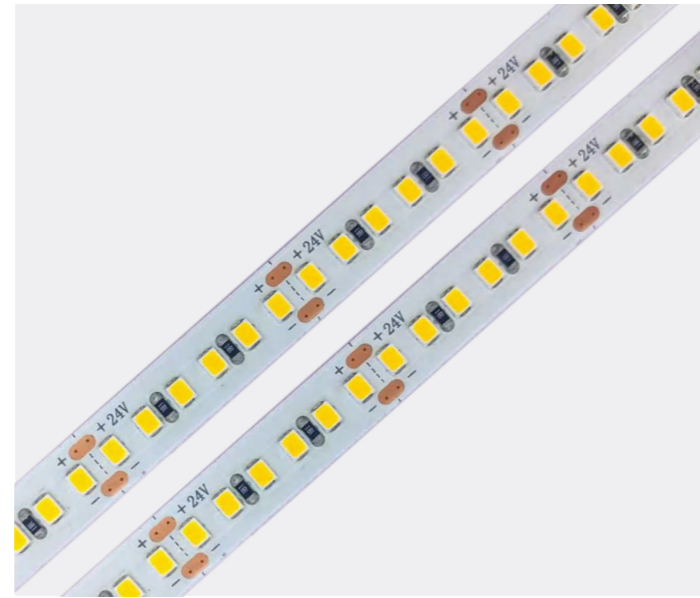

## Electrical Parameters

Light Beads:	2835
LED Qty:	180pcs/m
Width:	10mm
Voltage:	DC24V
Power:	14W/M
CRI:	90
LM/M:	1300
Color:	3000K/4000K/6500K



## Cut size

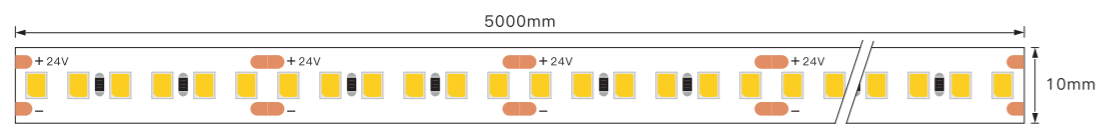
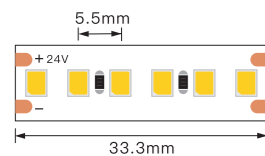

# RG-2835-240-10mm-D

## Feature

1. Double row with high brightness
2. Stable and Low light decay
3. Excellent color rendering, RA>80 or 90
4. Double layer copper PCB for good heat dissipation

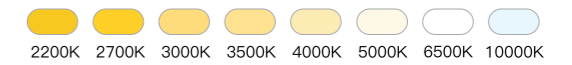
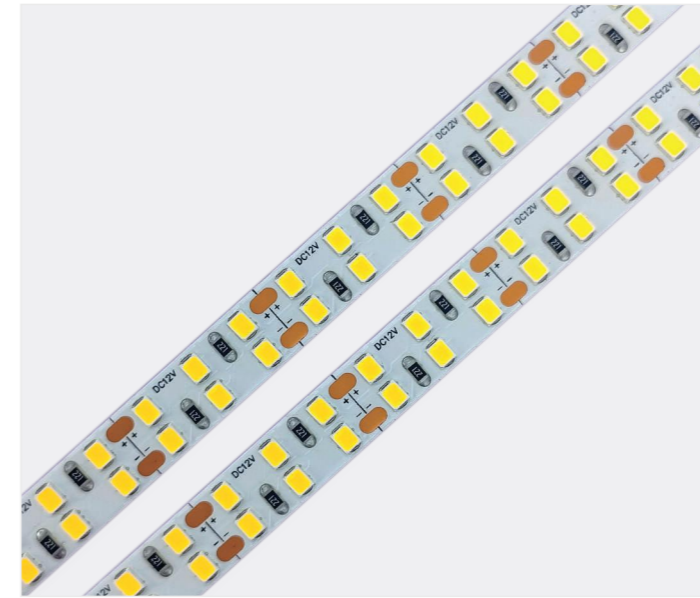

## Electrical Parameters

Light Beads:	2835
LED Qty:	240pcs/m
Width:	10mm
Voltage:	DC12V/24V
Power:	16W/M
CRI:	90
LM/M:	1870
Color:	3000K/4000K/5000K/6500K



## Cut size

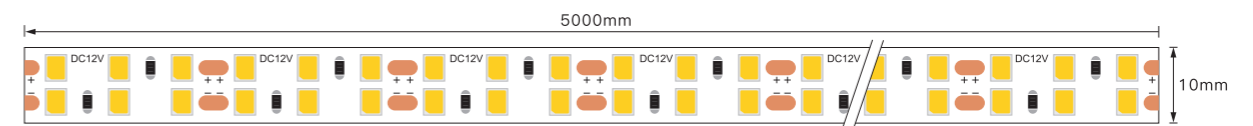
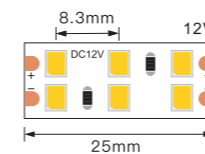

## RG-2835-240-15mm

### Feature

1. 2835 240LED/M with uniform light
2. Good product for small size cabinet linear light
3. Excellent color rendering, RA>90
4. 12V or 24v are available

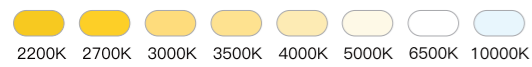
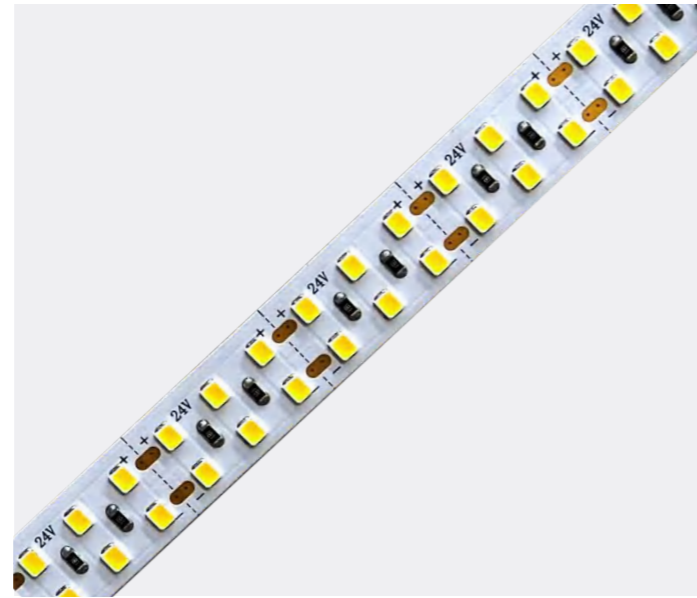

### Electrical Parameters

Light Beads:	2835
LED Qty:	240pcs/m
Width:	15mm
Voltage:	DC24V
Power:	18.5W/M
CRI:	90/95
LM/M:	1810
Color:	3000K/4000K/5000K/6500K



### Cut size

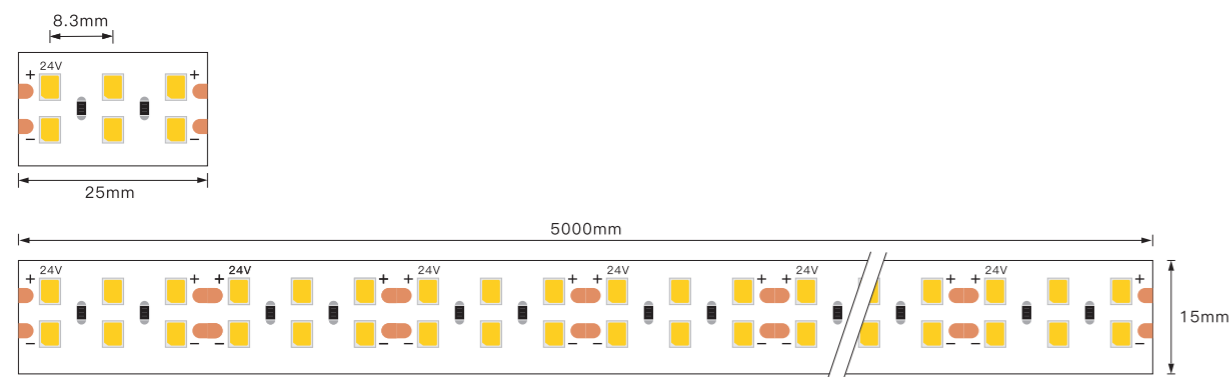

## RG-2835-360-20mm

### Feature

1. Excellent color rendering, RA>90 or 95
2. Double layer copper PCB for good heat dissipation
3. High brightness with 28W/m for project
4. Suitable for commercial lighting

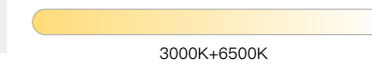
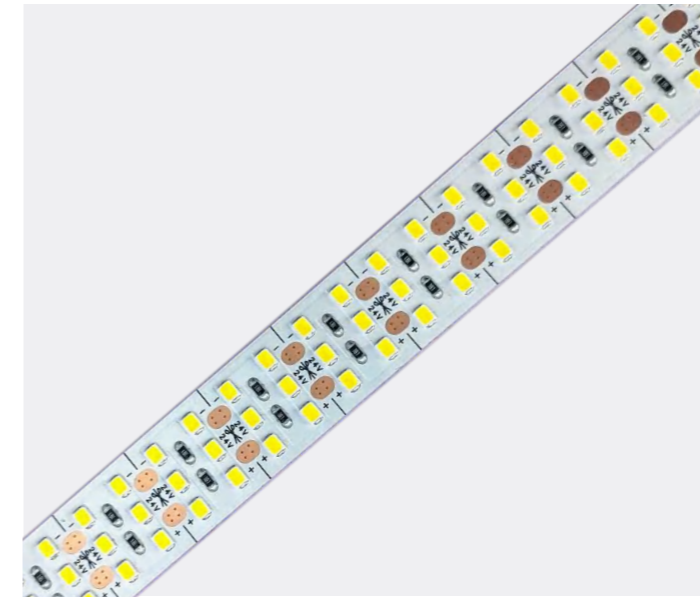

### Electrical Parameters

Light Beads:	2835
LED Qty:	360pcs/m
Width:	20mm
Voltage:	DC24V
Power:	28W/M
CRI:	90/95
LM/M:	3100
Color:	3000K/4000K/5000K/6500K



### Cut size

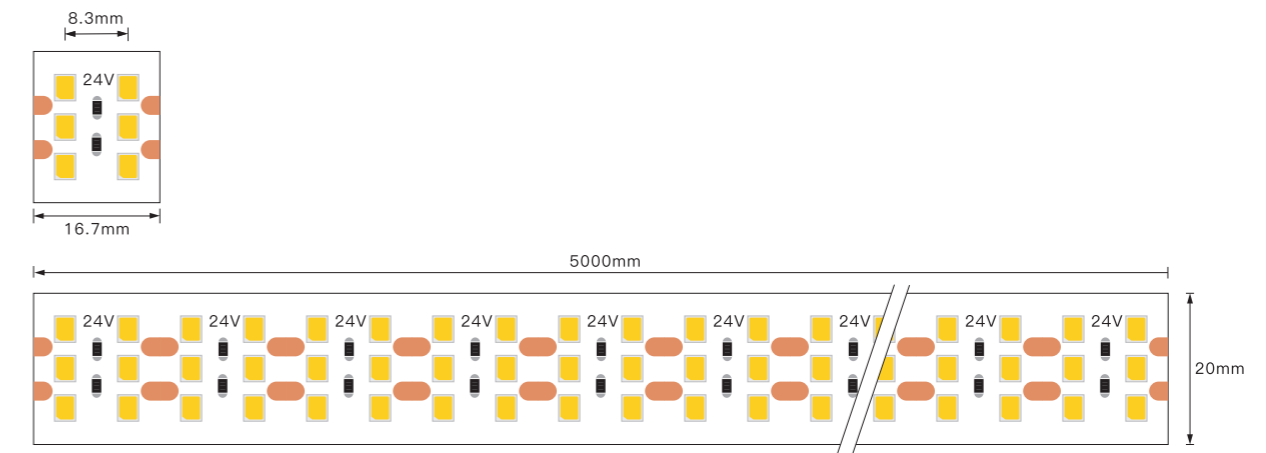

## RG-S-2835-120-8mm

### Feature

1. The S-shaped Zigzag design makes bending easier
2. It can be combined with special-shaped profile to design many lighting solutions
3. Excellent color rendering, RA>90



### Electrical Parameters

Light Beads:	2835
LED Qty:	120pcs/m
Width:	8mm
Voltage:	DC24V
Power:	9.6W/M
CRI:	90
LM/M:	880
Color:	3000K/4000K/5000K/6500K



### Cut size

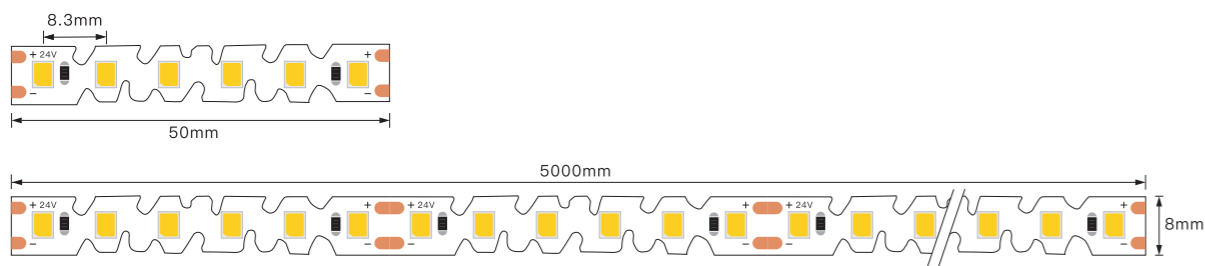

## RG-S-CCT-2835-120-8mm

### Feature

1. The S-shaped Zigzag design makes bending easier
2. It can be combined with special-shaped profile to design many lighting solutions
3. Excellent color rendering, RA>90
4. The color temperature can be adjusted from 2700K to 6500K

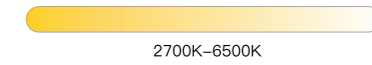

### Electrical Parameters

Light Beads:	2835
LED Qty:	120pcs/m
Width:	8mm
Voltage:	DC24V
Power:	9.6W/M
CRI:	90
LM/M:	860
Color:	2700-6500K



### Cut size

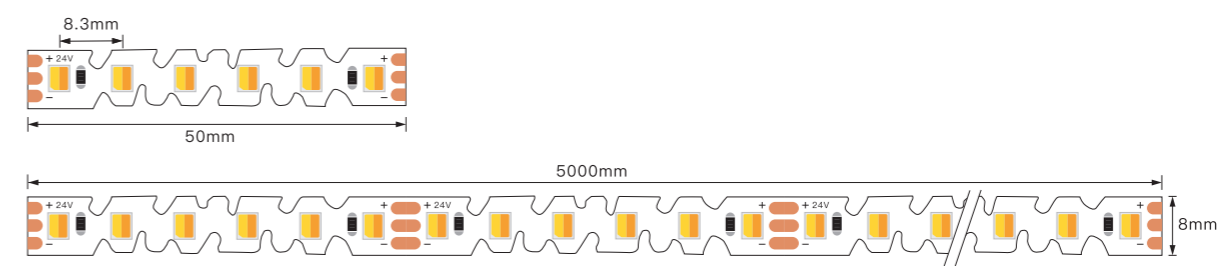



Zigzag LED strip

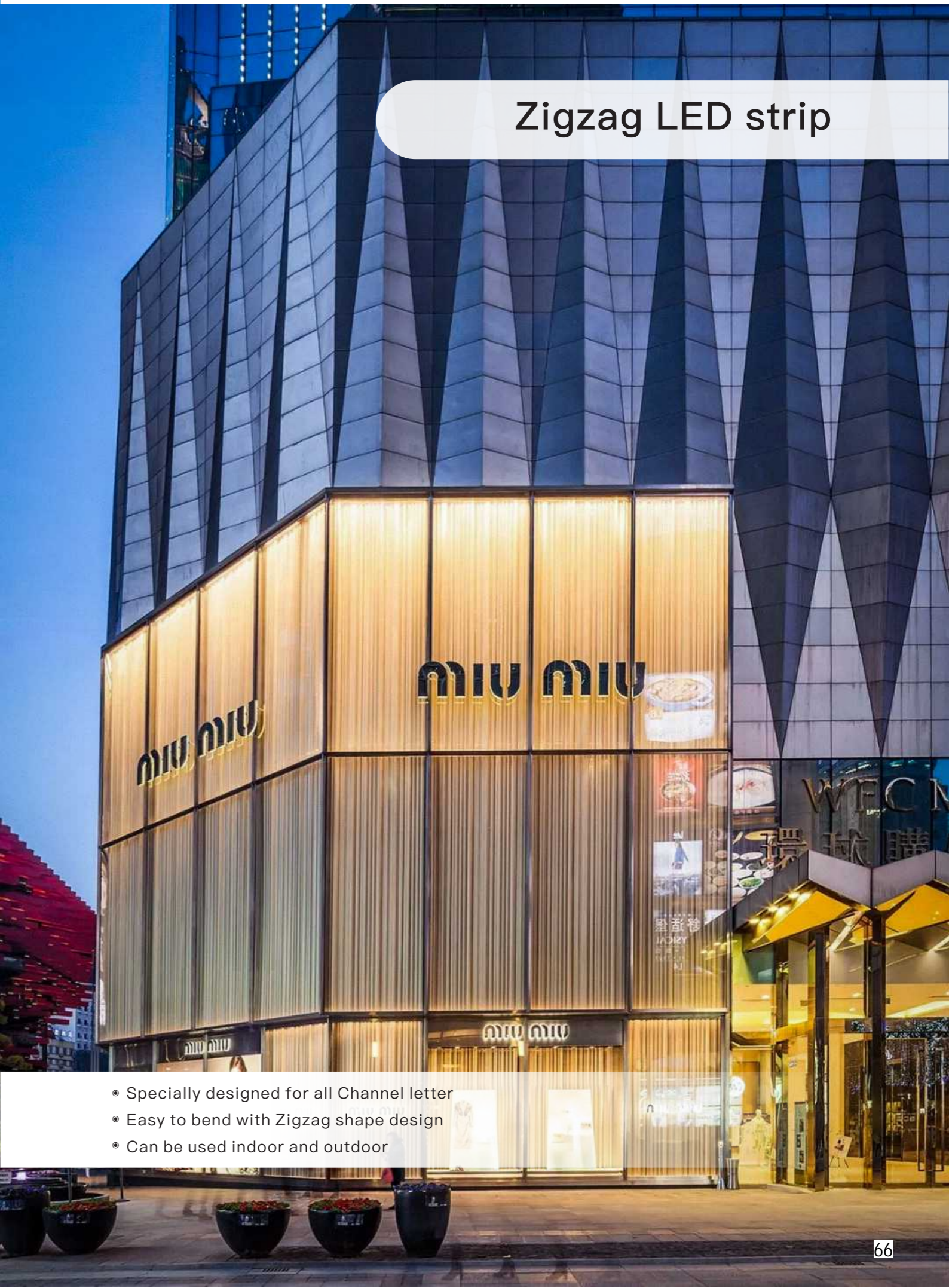

- Specially designed for all Channel letter
- Easy to bend with Zigzag shape design
- Can be used indoor and outdoor

## ZZ-2835-120-6.5mm

### Feature

1. The Unique S-type zigzag design allows for bending the strip easily
2. IP20 and IP67(Spray glue) are available
3. Work with separate neon to make neon sign
4. Mini letter/Resin letter/Super letter/Stainless steel letter
5. All colors are available, W/R/G/B/Ice blue/Pink/Purple/Yellow/Lemon yellow



### Electrical Parameters

Light Beads:	2835
LED Qty:	120pcs/m
Width:	6.5mm
Voltage:	DC12V
Power:	7.2W/M
CRI:	80
LM/M:	675
Color:	3000K/4000K/6500K/10000K



### Cut size

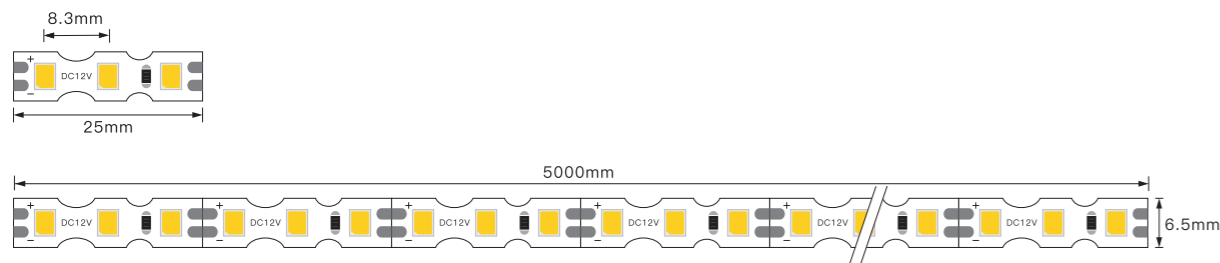

## ZZ-RGB-3535-84-7mm

### Feature

1. Specially designed for SIGN market
2. Low consumption and high brightness
3. The LED strip are rainproof Ip54
4. RGB color
5. For resin letter/Super letter/Stainless steel letter



### Electrical Parameters

Light Beads:	3535
LED Qty:	84pcs/m
Width:	7mm
Voltage:	DC12V
Power:	14W/M
Color:	RGB



### Cut size

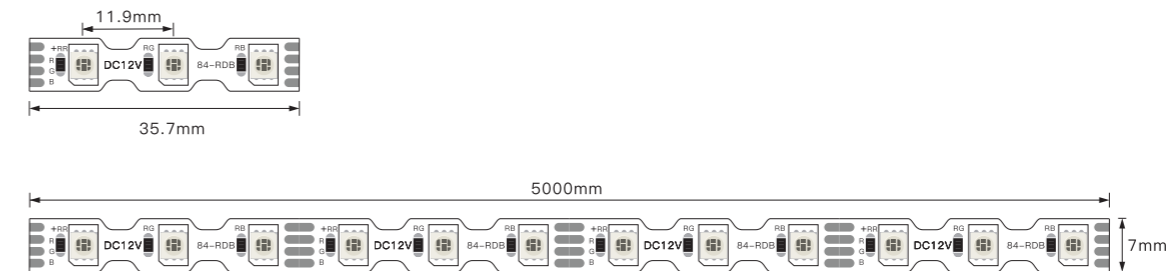

## ZZ-2835-60-7.1mm

### Feature

1. Specially designed for SIGN market with big LED chip
2. Low consumption and high brightness, lifespan up to 3-5 years
3. The LED strip are rainproof Ip54
4. Can be folded into 180 degree to be layout in shell
5. For Mini letter / Resin letter/Super letter/Stainless steelletter



### Electrical Parameters

Light Beads:	2835
LED Qty:	60pcs/m
Width:	7.1mm
Voltage:	DC12V
Power:	10W/M
CRI:	80
LM/M:	905
Color:	R/G/B/Y/White



### Cut size

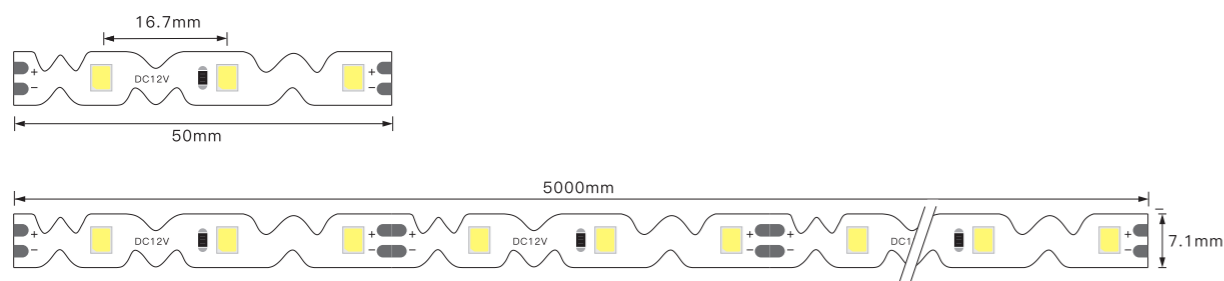

## ZZ-2835-60-7.1mm-D

### Feature

1. Specially zigzag designed for SIGN market with big LED chip
2. Double layer copper PCB, Low consumption, lifespan up to 3-5 years
3. The LED strip are rainproof Ip54
4. For Mini letter/Resin letter/Super letter/Stainless steelletter



### Electrical Parameters

Light Beads:	2835
LED Qty:	60pcs/m
Width:	7.1mm
Voltage:	DC12V
Power:	10W/M
CRI:	80
LM/M:	910
Color:	3000K/4000K/5000K/6500K



### Cut size

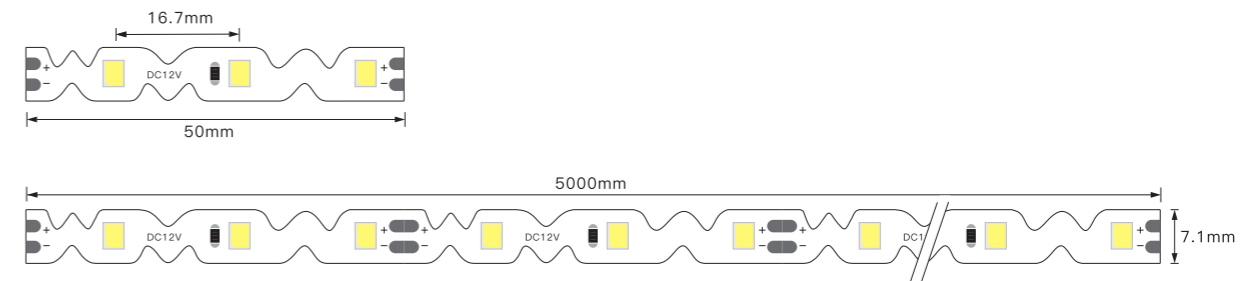

## ZZ-5050-60-8.8mm

### Feature

1. Easy to bend, stable quality and high brightness
2. The S-type zigzag design allows to make letters easier
3. IP20 and IP67(Spray glue) are available
4. 5/10/20M/roll
5. For Super letter/Boundless letter/Stainless steel letter



### Electrical Parameters

Light Beads:	5050
LED Qty:	60pcs/m
Width:	8.8mm
Voltage:	DC12V
Power:	12W/M
CRI:	80
LM/M:	1200
Color:	3000K/4000K/6500K/10000K



### Cut size

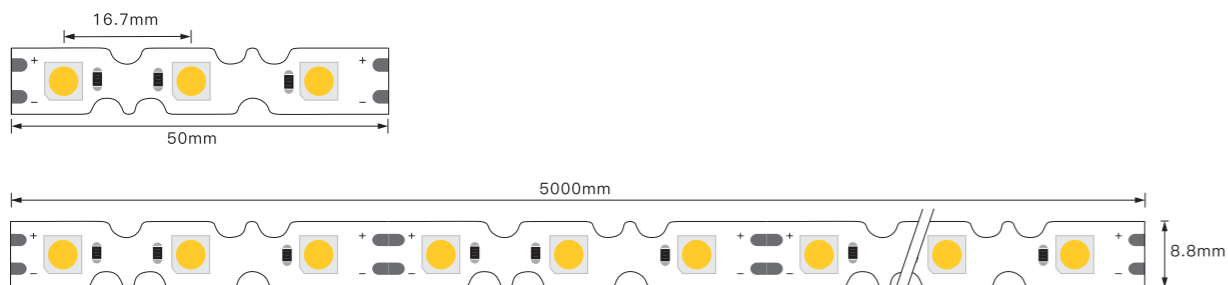

## ZZ-6060-36-8.8mm

### Feature

1. The light will be more uniform
2. Cut free and Maintenance-free
3. Flexible and easy to bend
4. Large beam angel 160 degree
5. For Super letter/Boundless letter/Stainless steel letter

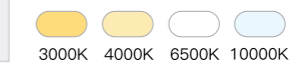

### Electrical Parameters

Light Beads:	6060
LED Qty:	36pcs/m
Width:	8.8mm
Voltage:	DC12V
Power:	14W/M
CRI:	80
LM/M:	1230
Color:	3000K/4000K/6500K/10000K



### Cut size

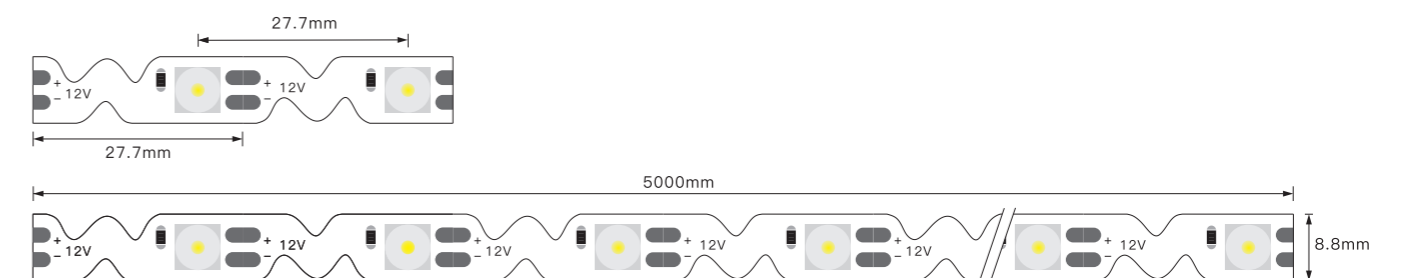

COB LED series

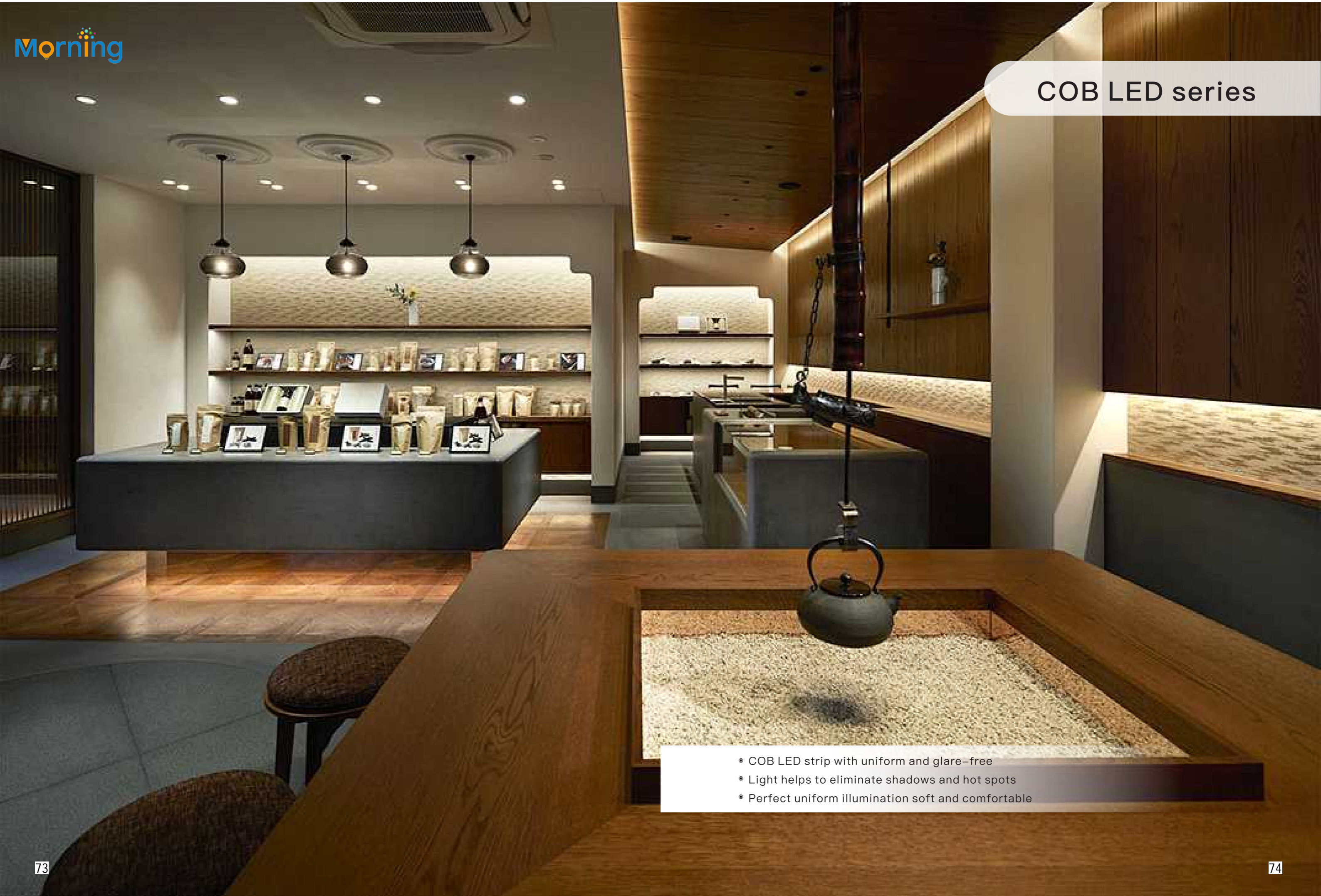

- COB LED strip with uniform and glare-free
- Light helps to eliminate shadows and hot spots
- Perfect uniform illumination soft and comfortable

## COB-312-8mm

### Feature

1. Perfect uniform illumination soft and comfortable
2. High cost performance
3. 180-degree beam angle,CRI 90
4. For cabinet /furniture/showcase

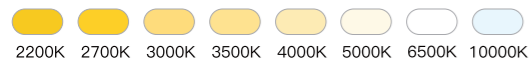
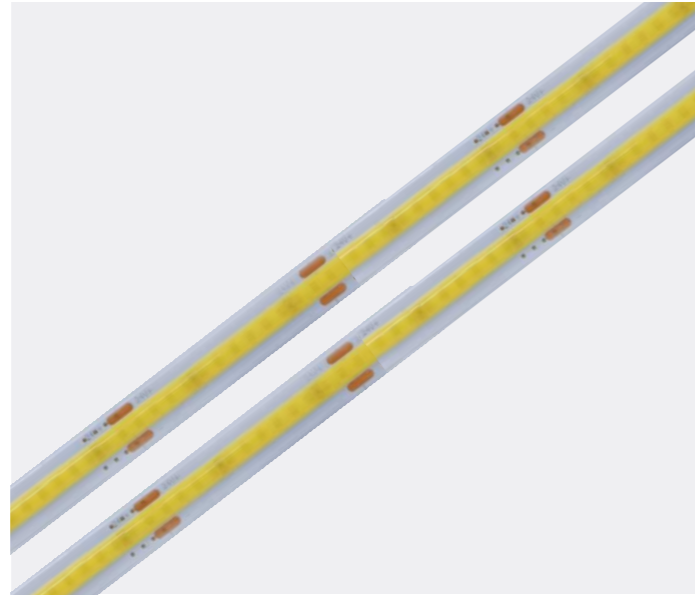

### Electrical Parameters

Light Beads:	COB
LED Qty:	312pcs/m
Width:	8mm
Voltage:	DC12V
Power:	10W/M
CRI:	90
LM/M:	840
Color:	3000K/4500K/6500K



### Cut size

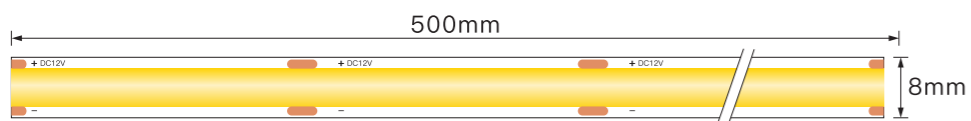
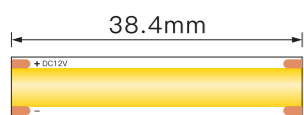

## COB-320-8mm

### Feature

1. Perfect uniform illumination soft and comfortable
2. Unparalleled linear light effect
3. High cost performance
4. 180-degree beam angle,CRI 90
5. High density good linear effect

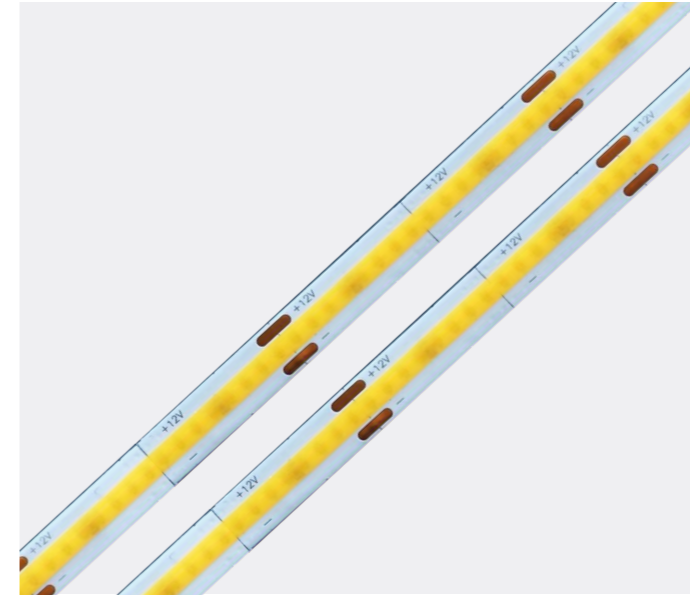

### Electrical Parameters

Light Beads:	COB
LED Qty:	320pcs/m
Width:	8mm
Voltage:	DC12V
Power:	10W/M
CRI:	90
LM/M:	840
Color:	3000K/4000K/6500K



### Cut size

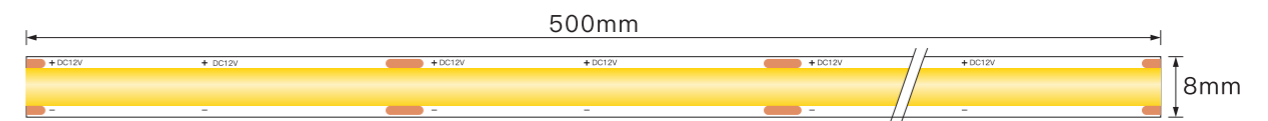
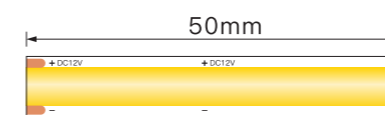

## COB-400-5mm

### Feature

1. Perfect uniform illumination soft and comfortable
2. No dark dot spots
3. Unparalleled linear light effect
4. High cost performance
5. Narrow FPCB width: 5mm
6. High density good linear effect

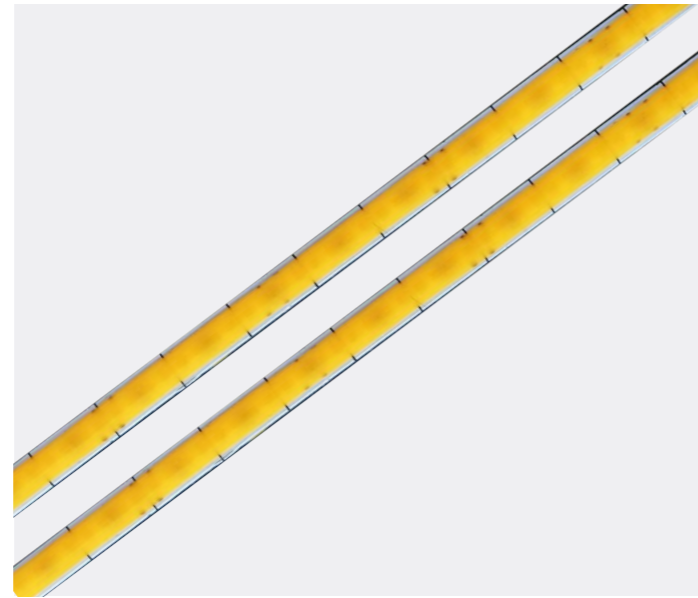

### Electrical Parameters

Light Beads:	COB
LED Qty:	400pcs/m
Width:	5mm
Voltage:	DC12V
Power:	11W/M
CRI:	90
LM/M:	1200
Color:	3000K/4000K/6500K



### Cut size

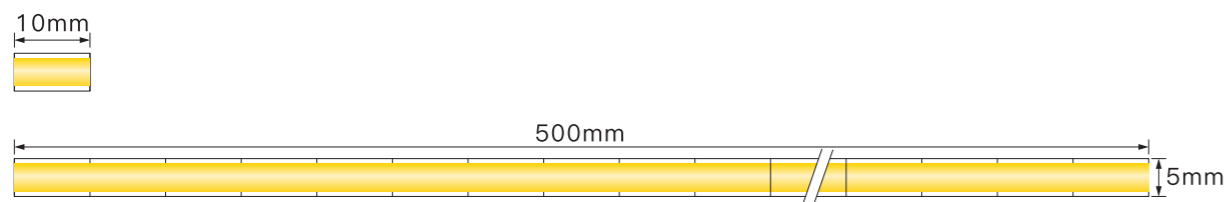

## COB-480-8mm

### Feature

1. Perfect uniform illumination soft and comfortable
2. No dark dot spots
3. Unparalleled linear light effect
4. High cost performance
5. 180-degree beam angle, CRI 90
6. High density good linear effect

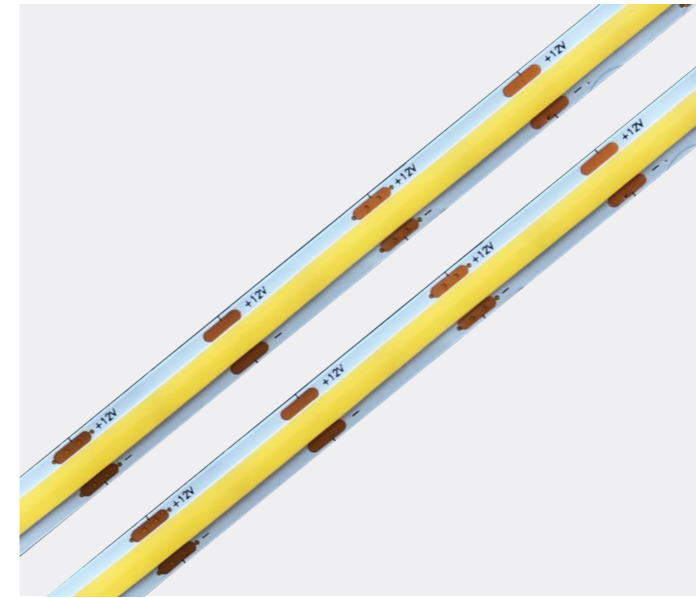

### Electrical Parameters

Light Beads:	COB
LED Qty:	480pcs/m
Width:	8mm
Voltage:	DC12V
Power:	12W/M
CRI:	90
LM/M:	1420
Color:	3000K/4000K/6500K



### Cut size

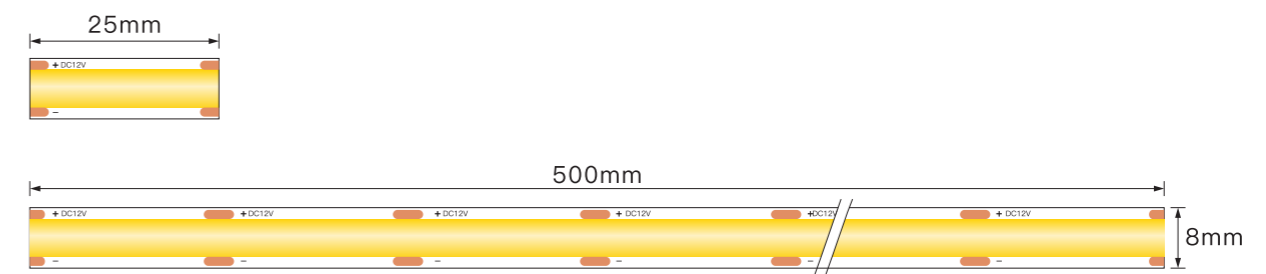

## COB-CF-528-8mm

### Feature

1. Perfect uniform illumination, soft and comfortable
2. Cut free
3. Stable and low light decay
4. Double layer 2 oz copper PCB for good heat dissipation
5. Longer operation life and better energy efficiency

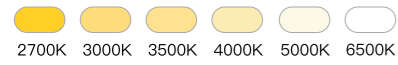
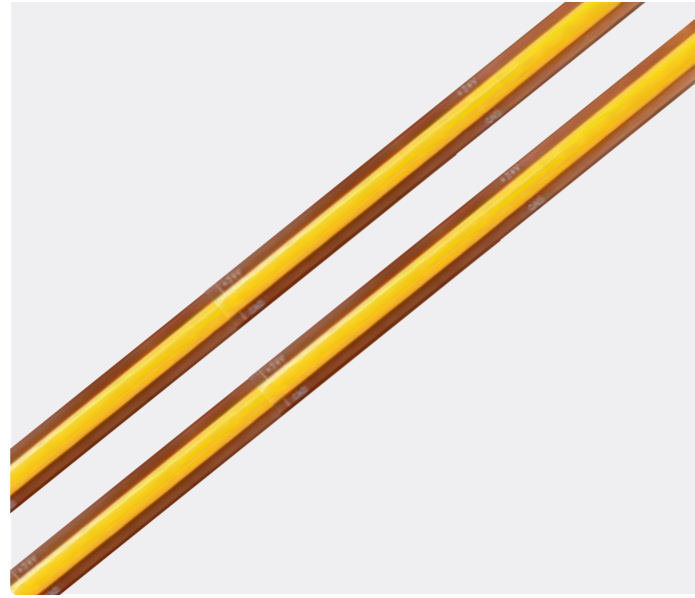

### Electrical Parameters

Light Beads:	COB
LED Qty:	528pcs/m
Width:	8mm
Voltage:	DC12V
Power:	13W/M
CRI:	90
LM/M:	1320
Color:	3000K/4000K/6500K



### Cut size

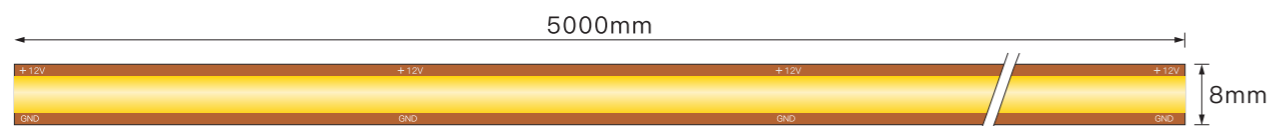

## COB-RGB-576-8/10mm

### Feature

1. Perfect uniform illumination, soft and comfortable
2. No dark dot spots
3. RGB Color
4. Thick double layer 2 oz copper PCB for good heat dissipation
5. 180-degree beam angle



### Electrical Parameters

Light Beads:	COB
LED Qty:	576pcs/m
Width:	8/10mm
Voltage:	12/24V
Power:	14W/M
Color:	RGB



### Cut size

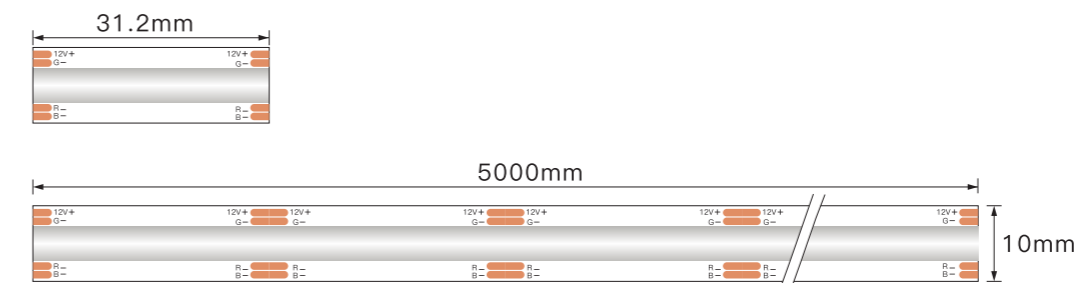

## COB-CCT-600-8mm-2 Wire

### Feature

1. Perfect uniform illumination, soft and comfortable
2. No dark dot spots
3. CCT White: 2700K-6500K with 2 wire
4. 180-degree beam angle,CRI 90
5. High density good linear effect

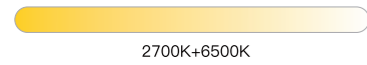
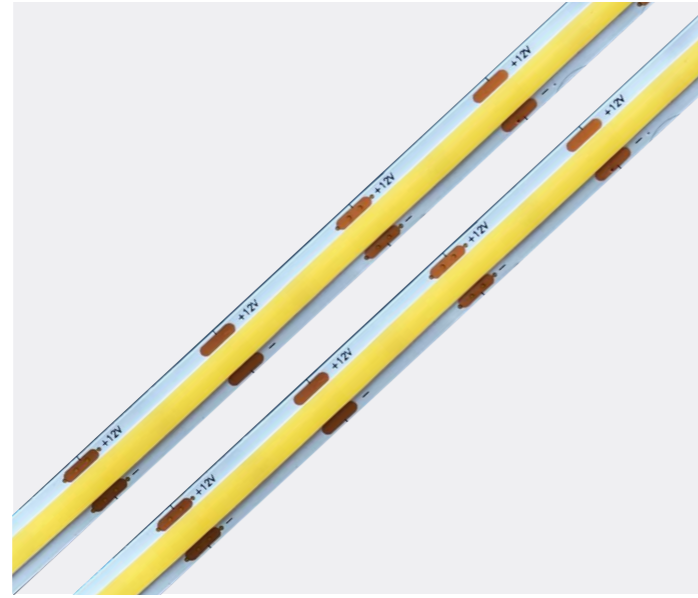

### Electrical Parameters

Light Beads:	COB
LED Qty:	600pcs/m
Width:	8mm
Voltage:	24V
Power:	14W/M
CRI:	90
LM/M:	635
Color:	2700-6500K



### Cut size

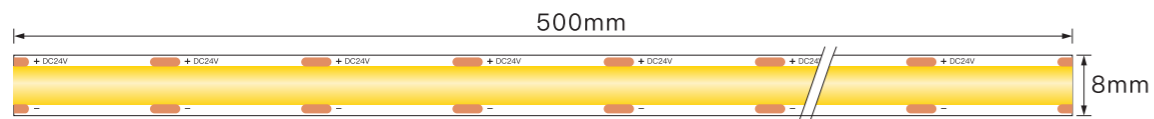
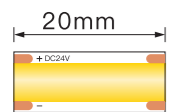

## COB-CCT-608-8mm-3 Wire

### Feature

1. Perfect uniform illumination, soft and comfortable
2. No dark dot spots
3. CCT White: 2700K-6500K
4. Thick double layer 2 oz copper PCB for good heat dissipation
5. 180-degree beam angle,CRI 90
6. High density good linear effect

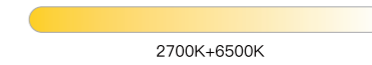
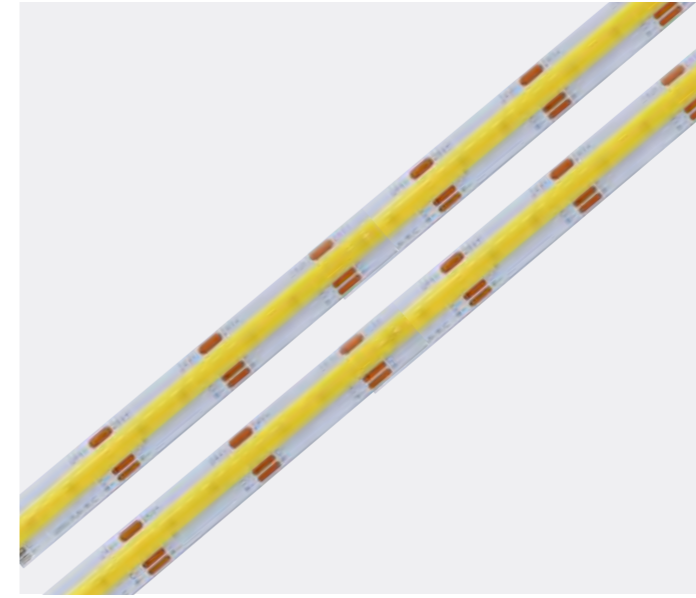

### Electrical Parameters

Light Beads:	COB
LED Qty:	608pcs/m
Width:	8mm
Voltage:	12V
Power:	12W/M
CRI:	90
LM/M:	635
Color:	2700-6500K



### Cut size

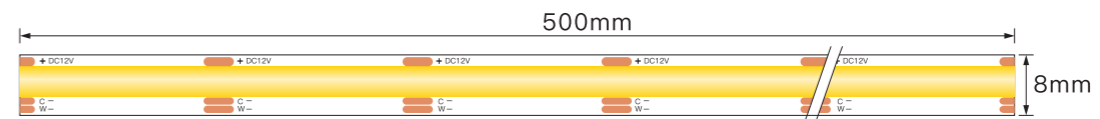
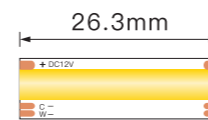

- Adopting pure silicone dual color extrusion technology, with a cutting point design for convenient cutting and use
- It can maintain a normal soft state when used within  $-20\text{ }^{\circ}\text{C}\sim+45\text{ }^{\circ}\text{C}$ , without any adverse conditions such as brittleness, deformation, softening, aging, etc.
- IP65 protection level, resistant to salt solution, acid and alkali, and corrosive gases, fire-resistant
- Uniform, soft, and free from light spots

## Side View 4\*10(mm)

Lighting Direction: Side Lighting

Cutting mark: Yes

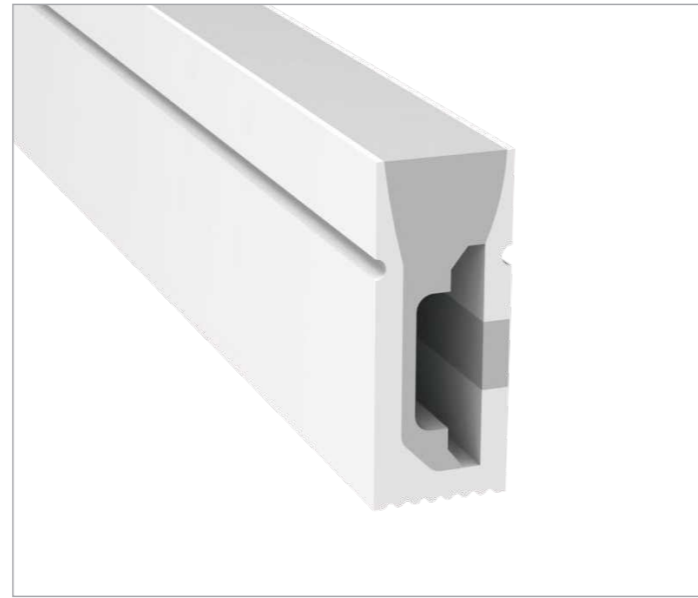
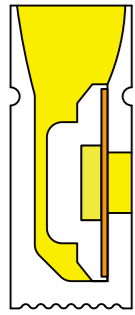

### Electrical Parameters

PCB Width (mm) 5/6

Weight (g/m) 47

Section size (mm) 4\*10

Beam angle 180°

Aluminum Profile size(mm)

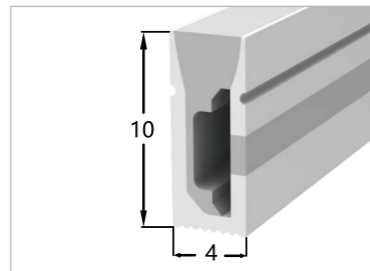
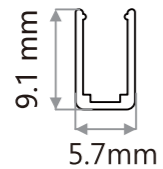

### Accessories



End cap with hole



End cap no hole



Aluminum Clip



Aluminum Profile



Flexible Profile

## Side View 8\*16 (mm)

Lighting Direction: Side Lighting

Cutting mark: Yes



### Electrical Parameters

PCB Width (mm) 8

Weight (g/m) 112

Section size (mm) 8\*16

Beam angle 180°

Aluminum Profile size(mm)

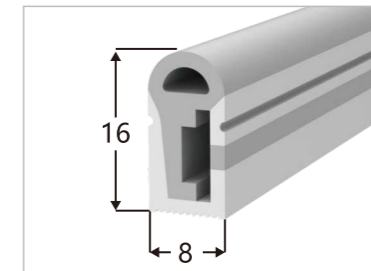
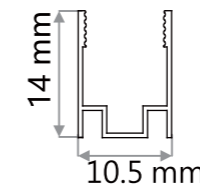

### Accessories



End cap with hole



End cap no hole



Aluminum Clip



Aluminum Profile



Flexible Profile

## Side View 10\*23(mm)

Lighting Direction: Side Lighting

Cutting mark: Yes

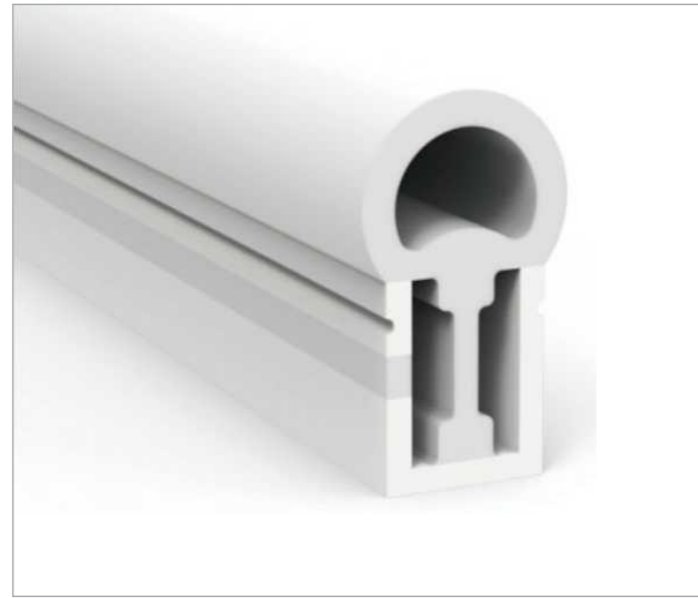
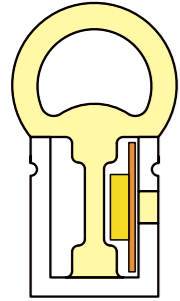

### Electrical Parameters

PCB Width (mm) 10  
 Weight (g/m) 196  
 Section size (mm) 10\*23  
 Beam angle 270°  
 Aluminum Profile size(mm)

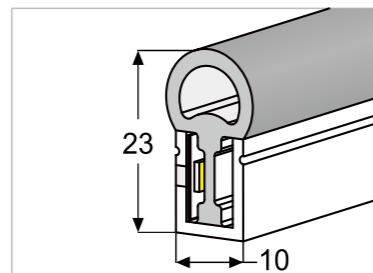
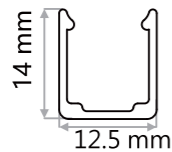

### Accessories



End cap with hole    End cap no hole    Aluminum Clip    Aluminum Profile    Flexible Profile

## Side View 16\*16(mm)

Lighting Direction: Side Lighting

Cutting mark: Yes

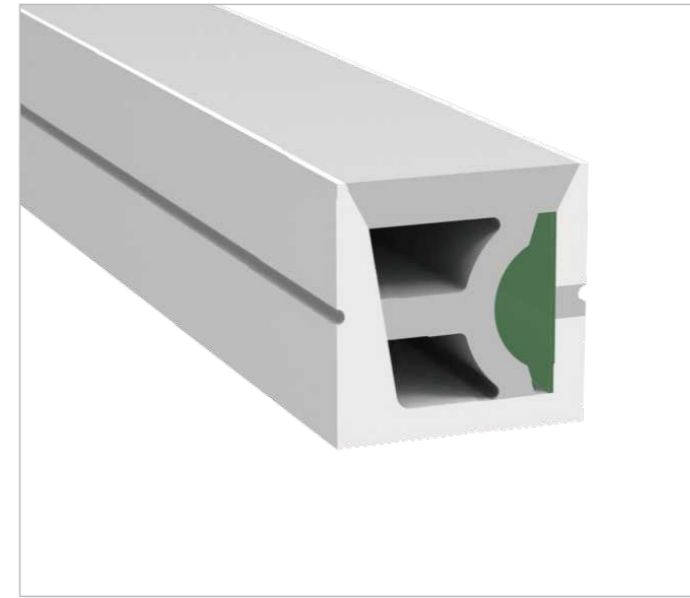
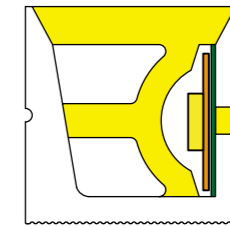

### Electrical Parameters

PCB Width (mm) 10  
 Weight (g/m) 241  
 Section size (mm) 16\*16  
 Beam angle 120°  
 Aluminum Profile size(mm)

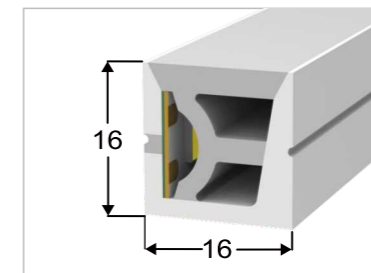
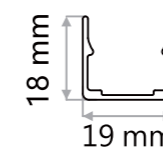

### Accessories



End cap with hole    End cap no hole    Aluminum Clip    Aluminum Profile    Flexible Profile

## Top View 10\*10(mm)

Lighting Direction: Side Lighting

Cutting mark: Yes

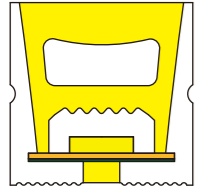

### Electrical Parameters

PCB Width (mm) 8

Weight (g/m) 105

Section size (mm) 10\*10

Beam angle 120°

Aluminum Profile size(mm)

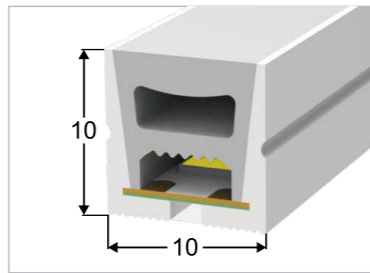
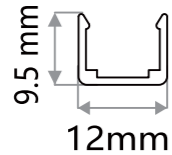

### Accessories



End cap with hole

End cap no hole

Aluminum Clip

Aluminum Profile

Flexible Profile

## Top View 12\*12(mm)

Lighting Direction: Side Lighting

Cutting mark: Yes

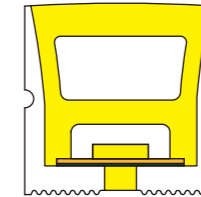

### Electrical Parameters

PCB Width (mm) 8

Weight (g/m) 135

Section size (mm) 12\*12

Beam angle 120°

Aluminum Profile size(mm)

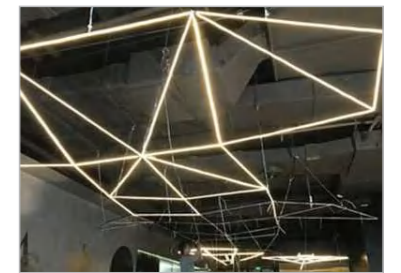
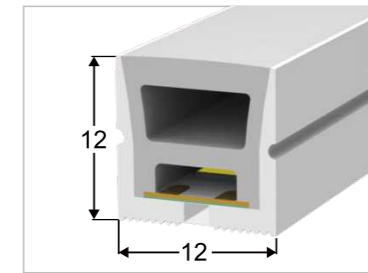
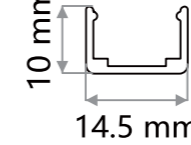

### Accessories



End cap with hole

End cap no hole

Aluminum Clip

Aluminum Profile

Flexible Profile

## Top View 16\*16(mm)

Lighting Direction: Side Lighting

Cutting mark: Yes

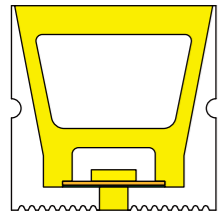

### Electrical Parameters

PCB Width (mm) 8/10

Weight (g/m) 250

Section size (mm) 16\*16

Beam angle 120°

Aluminum Profile size(mm)

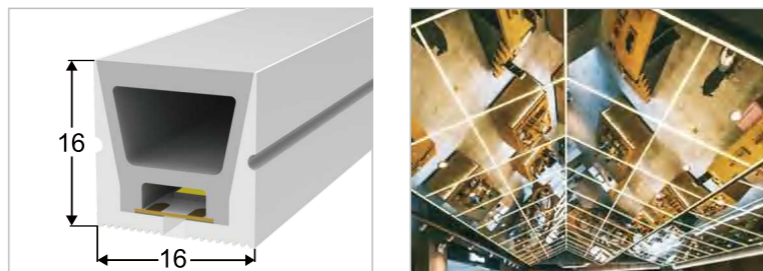

### Accessories



End cap with hole    End cap no hole    Aluminum Clip    Aluminum Profile    Flexible Profile

## 08\*16 RGB LED Neon



### Feature

1. Size with 08\*16
2. It is dot-free and pure silicone material
3. RGB color
4. 5M blister packing or 100M/ROLL



### Electrical Parameters

Size(mm) 08\*16

Wattage (W/M) 8W/M

Volatge: 12V/24V

Material: Pure silicone

Lighting Direction: Side lighting

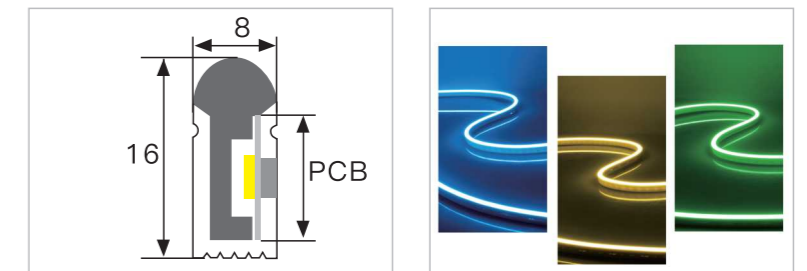

### Accessories



End cap with hole    End cap no hole    Aluminum Clip    Aluminum Profile    Flexible Profile

## Separate Neon Silicone tube

### Feature

1. Every 3 led is cuttable with 12v voltage
2. High cost performance and all color are available
3. S-type zigzag allows to bend easily
4. Ip20 and IP67(Spray glue) are available
5. 10M/20M/50M/roll



### Electrical Parameters

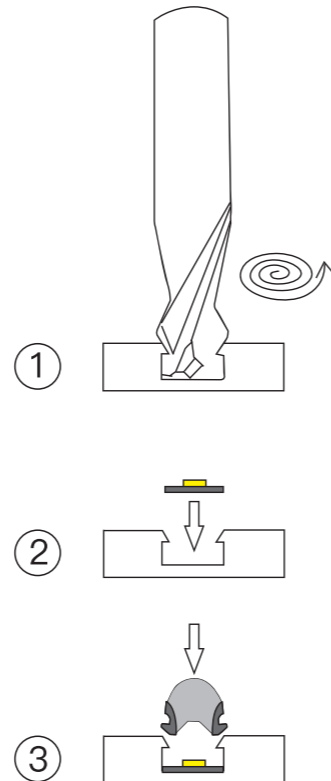
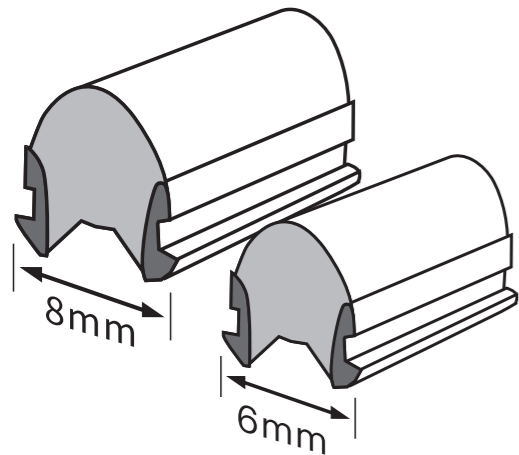

## 5M blister packing Neon

### Feature

1. Size with 06\*12 and 08\*13
2. Cut with every led/1cm
3. It is dot-free
4. All color are available
5. 5m blister packing or 100M/Roll



### Electrical Parameters



Part No	LED/M	Width	Voltage	Color
06*12Neon	100/120	6mm	DC12V-7.5W	R/G/B/W/Y/O/Ice blue/Rose
08*13Neon	100/120	8mm	DC12V-7.5W	R/G/B/W/Y/O/Ice blue/Rose

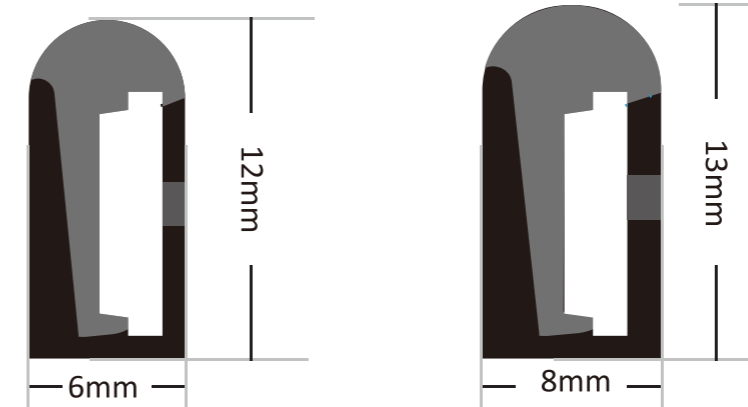

## RGB RGBW LED Strip

Morning

- RGB /RGBW/RGBWW Color
- RGBW LED strip control the color and brightness remotely
- It can be used in a variety of scenarios ,such as background walls, TV backgrounds, room ceiling lights...

## RGB-3535-120-8mm

### Feature

1. RGB Color
2. Thick double layer 2 oz copper PCB for good heat dissipation
3. Long life, good stability, and energy saving
4. RGB LED strip control the color and brightness remotely



RGB



### Electrical Parameters

Light Beads:	3535
LED Qty:	120pcs/m
Width:	8mm
Voltage:	DC12/24V
Power:	9.6W/M
Color:	RGB



### Cut size

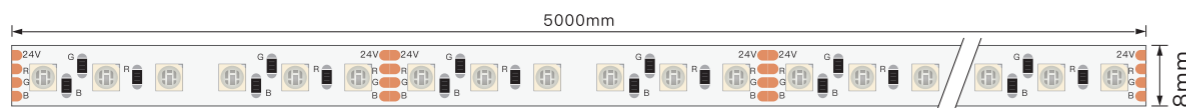
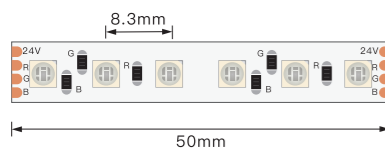

## RGB-5050-60-10mm

### Feature

1. RGB Color
2. Thick double layer 2 oz copper PCB for good heat dissipation
3. Long life, good stability, and energy saving
4. RGB LED strip control the color and brightness remotely



RGB



### Electrical Parameters

Light Beads:	5050
LED Qty:	60pcs/m
Width:	10mm
Voltage:	DC12/24V
Power:	14.4W/M
Color:	RGB



### Cut size

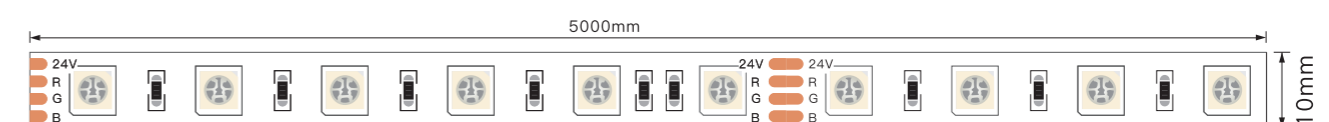
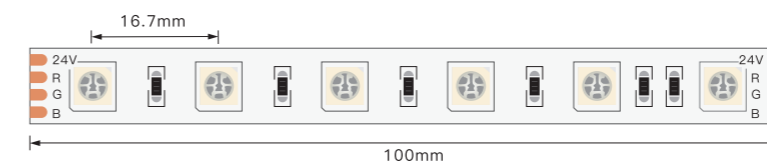

# RGBW-5050-60-10/12mm

## Feature

1. RGBW Color, RGB+3000K/4000k/6500K White
2. Thick double layer 2 oz copper PCB for good heat dissipation
3. Long life, good stability, and energy saving
4. RGBW LED strip control the color and brightness remotely



## Electrical Parameters

Light Beads: 5050  
 LED Qty: 60pcs/m  
 Width: 10mm/12mm  
 Voltage: DC12/24V  
 Power: 19.2W/M  
 Color: RGBW



## Cut size

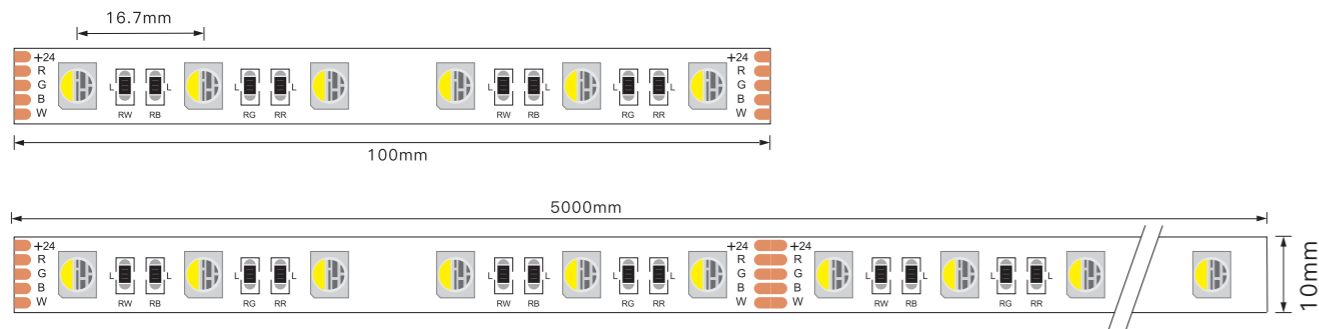

# RGBWW-5050-60-12mm

## Feature

1. RGBWW Color, 5 in one, RGB+2700K-6500K
2. Thick double layer 2 oz copper PCB for good heat dissipation
3. Long life, good stability, and energy saving
4. RGBWW LED strip control the color and brightness remotely

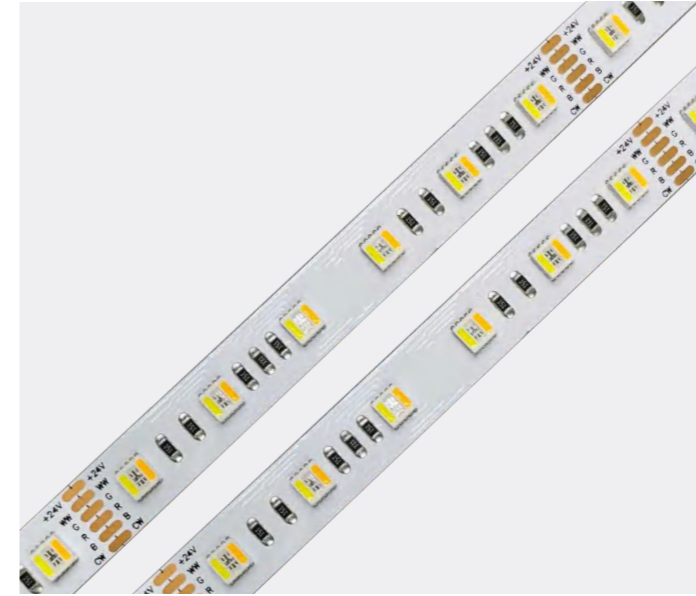

## Electrical Parameters

Light Beads: 5050  
 LED Qty: 60pcs/m  
 Width: 12mm  
 Voltage: DC12/24V  
 Power: 24W/M  
 Color: RGB+2700K-6500K



## Cut size

