



1

The NEW COB Strip



- Dotless lighting performance
- 180° beam angle
- DC24V, 12V
- Red, Green, Blue & White color
- 528&320 chips per meter
- Special connectors



COB STRIP LIGHTS

Item NO.	Photo	QTY/M	Voltage	W(mm)	Segment	W/M	Lm/M	Lm/W
24Vdc Input								
COB5282-R		528	24	10	45.45	10	/	/
COB5282-G		528	24	10	45.45	10	/	/
COB5282-B		528	24	10	45.45	10	/	/
COB5282-ER		528	24	10	45.45	10	1100	110
COB5282		528	24	10	45.45	15	1650	110
COB5282-CC		528	24	10	45.45	10	1100	110
COB3202		320	24	8	100	8	880	110
12Vdc Input								
COB5281		528	12	10	22.73	10	1100	110
COB5281		528	12	10	22.73	15	1650	110
COB5281-CC		528	12	10	22.73	10	1100	110
COB3201		320	12	8	50	8	880	110

2110 SERIES

New design 2110 SMD, stronger frame and durable

CRI90+, **R9>80**, good light quality

7 LED per unit, high efficient design.

2



2110 STRIP LIGHT

Item NO.	Photo	QTY/M	Voltage	W(mm)	Segment	W/M	Lm/M	Lm/W
M70208		70	24	8	100	4.8	432	90
M70208		70	24	8	100	7.2	648	90
M140208		140	24	8	50	9.6	864	90
M140208		140	24	8	50	14.4	1296	90
M280210		280	24	10	25	19.2	1728	90
M350210		350	24	10	20	24	2160	90
M700210		700	24	10	10	18	1620	90

2835 STRIP LIGHT

B30108		30	12	8	100	7	630	90
B48108		48	12	8	62.5	11	990	90
B60208		60	24	8	100	13	1170	90
B60108-G		60	12	8	50	13	/	/

2835 SERIES

The best selling series EVER,
2835 LED with LM80
Various Items, Full Covering
Max Ra97 available.

3



2835 STRIP LIGHT

Item NO.	Photo	QTY/M	Voltage	W(mm)	Segment	W/M	Lm/M	Lm/W
B60210-CC2		60	24	10	100	5	470	94
B78108		78	12	8	38.5	14	1260	90
B78208		78	24	8	77	14	1260	90
B84110		84	12	10	35.7	16	1440	90
B96210		96	24	10	62.5	17	1530	90
B120210		120	24	10	50	20	1800	90
B120212		120	24	12	50	20	1800	90
B140210		140	24	10	50	20	2500	125
B160212		160	24	12	50	16	2240	140
B168205		168	24	5	41.66	10	800	80
B224212		224	24	12	31.2	22	2310	105
B240212		240	24	12	25	22	2090	95

Color Options: ■ Red ■ Green ■ Blue ■ UV

Morning Go
www.mgoled.com

HIGH EFFICIENCY

Energy-Saving
More brightness with less power consumption.



5



2216 SERIES

High Density
Dotless inside aluminum profile
Single color, CCT all available.

RGB+2 IN 1 CCT

5 Colors
MiLight Controller.



3014 SIDE VIEW

Cost-Effective
Brighter than 335/315 SMD.

HIGH EFFICIENCY SERIES



Item NO.	Photo	QTY/M	Voltage	W(mm)	Segment	W/M	Lm/M	Lm/W
B64210		64	24	10	125	6.4	960	150
B128210		128	24	10	62.5	12.8	1920	150
B224210		224	24	10	35.71	22.4	3360	150

FUNCTIONAL SERIES

F60215-RGBCCT		60	24	15	166.67	13	/	/
C120206		120	24	6	50	9	810	90
L120210-RGB		120	24	10	50	18	28	504

LED LINEAR MODULE SERIES

G32220		32	24	20	140	14.4	145	2088
G48320		48	36	20	140	21.6	145	3132
G64220		64	48	20	140	28.8	145	4176

Color Options: ■ Red ■ Green ■ Blue ■ UV

Morning Go
www.mgoled.com

LINEAR LIGHTS

Super Brightness
Good light distributions
by new design.



Morning

4500+Lm

6

NEW DESIGN

Reasonable Arrangement
Holes for cable coming out
No dots on cover



792LEDs/M

Ultra brightness
High density
Good for light source



LINEAR LIGHT SERIES

Morning

Item NO.	Photo	QTY/M	Voltage	W(mm)	Segment	W/M	Lm/M	Lm/W
F120220		120	24	20	50	24	1920	80
F240215		240	24	15	50	24	2040	85
F240215		240	24	15	50	19.2	1440	75
F280220		280	24	20	50	30	3600	120
B320230		320	24	30	25	28	3640	130
B420230		420	24	30	33.33	35	4200	120
B480240		480	24	40	50	34	4420	130
B792222		792	24	22	22.7	52	5200	100
A840215		840	24	15	25	19	1900	100

LED STRIP STRUCTURE

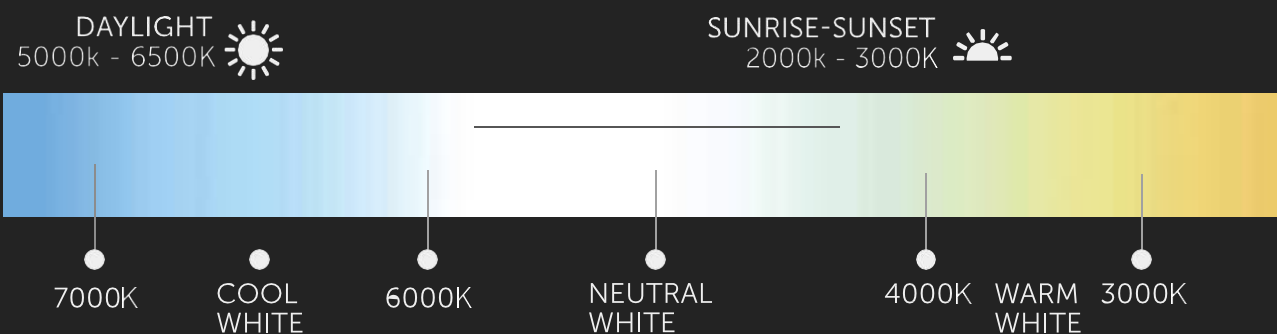
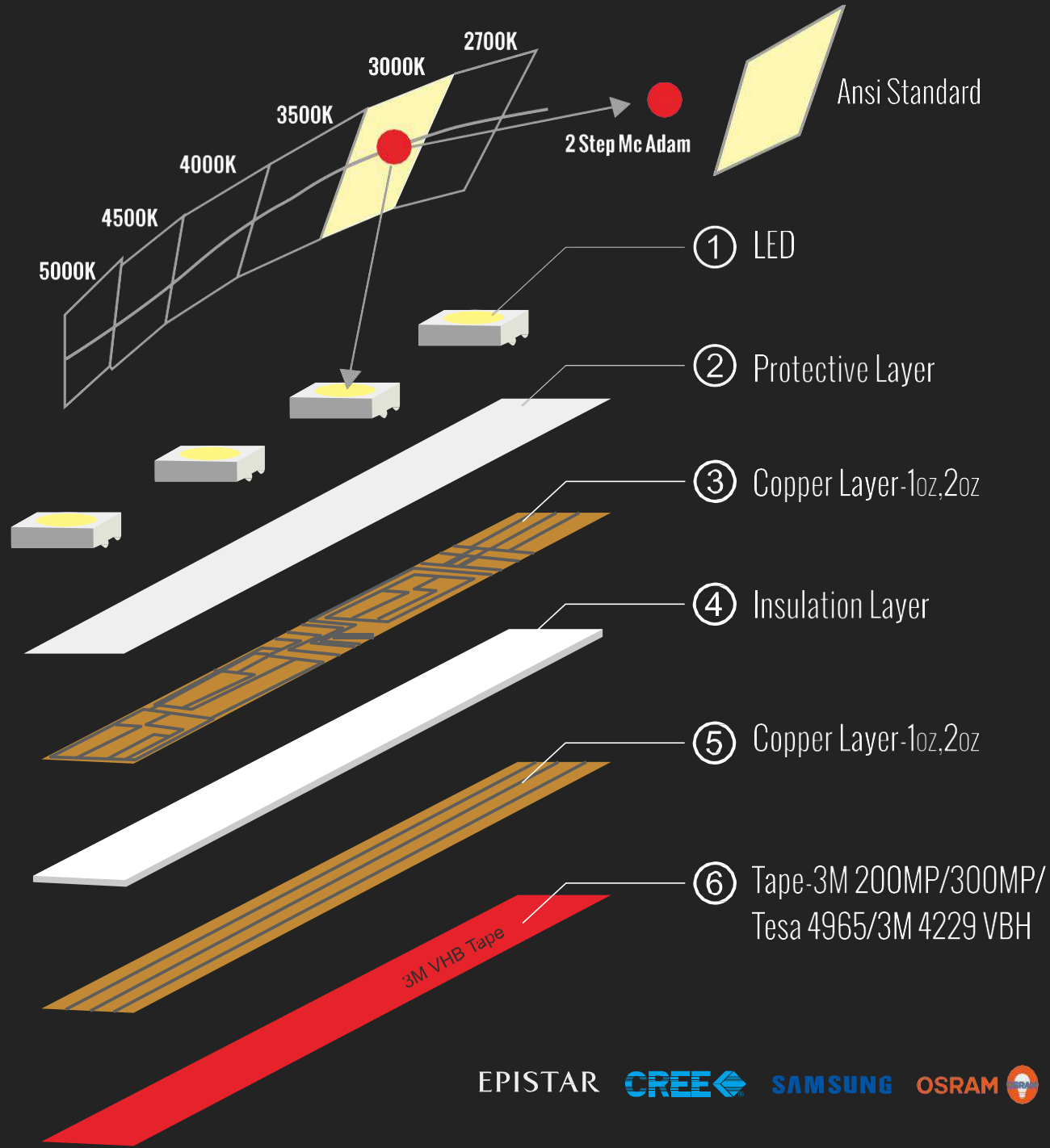

3528 SINGLE COLOR SERIES

Item NO.	Photo	QTY/M	Voltage	W(mm)	Segment	W/M	Lm/M	Lm/W
D60108		60	12	8	50	4.2	294	70
D60108-R		60	12	8	50	4.2	/	/
D60108		60	12	8	50	4.2	294	70
D60208		60	24	8	100	4.2	294	70
D78108		78	12	8	38.4	6.2	434	70
D78208		78	24	8	76.9	6.2	434	70
D120108		120	12	8	25	9.6	672	70
D120208		120	24	8	50	9.6	672	70
D240210		240	24	10	25	19.2	1344	70
D240212		240	24	12	25	19.2	1344	70

315/335 SIDE VIEW SERIES

H140210		140	24	10	50	9.6	672	70
H140210-CCT		140	24	10	100	9.6	672	70
160108		60	12	8	50	4.8	336	70
I120108		120	12	8	25	9.6	336	70

Color Options: ■ Red ■ Green ■ Blue ■ UV



① Dry the position to be flat and smooth before putting on the strips.

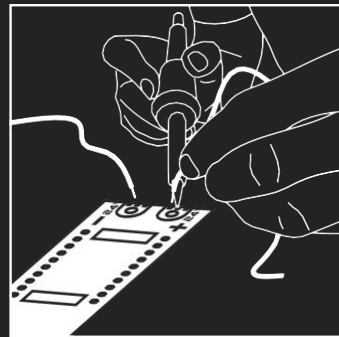

③ Solder wires on soldering pads (label +/-). The solder temperature may not exceed 350°C for maximum duration of 2 seconds.

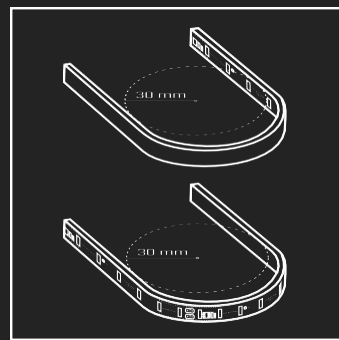

⑤ LED tapes are bendable. Minimum bend radius is 30 mm.

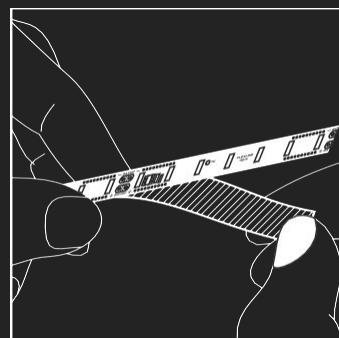

⑦ Remove the adhesive tape from the back side of the LED tape.

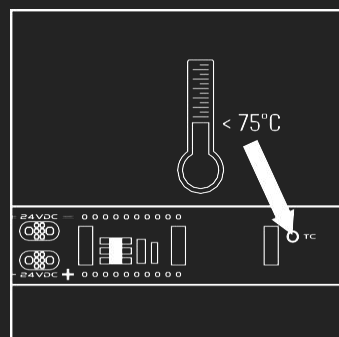

⑨ LED tapes must be installed on aluminum (or material with similar thermal conduction) to avoid LEDs overheating and ensure proper heat dissipation. Measure TC temperature after 30 minutes of operation. TC temperature should not exceed 75°C.

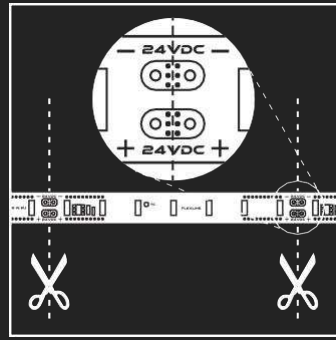

② LED tape can be cut only between soldering pads.

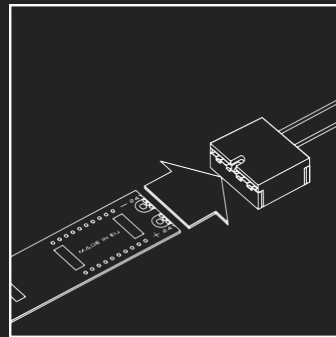

④ You can also connect strips using LED tape connectors.

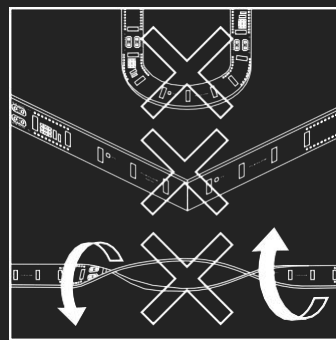

⑥ LED tapes cannot be bent or twisted in the demonstrated directions.

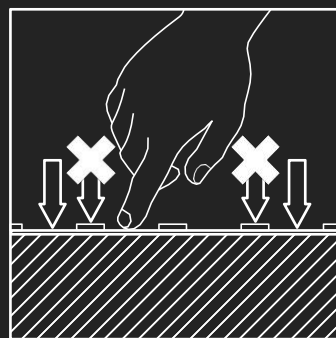

⑧ Press the LED tape gently between electronic components to stick it to the surface. Avoid pressing electronic components.

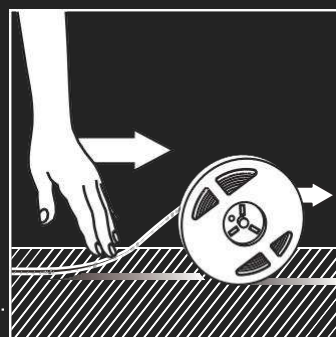

⑩ Keep the LED tape on the reel while applying it onto the surface. Remove the adhesive tape and apply the tape while unrolling the reel at the same time.

5050 SINGLE COLOR SERIES

Item NO.	Photo	QTY/M	Voltage	W(mm)	Segment	W/M	Lm/M	Lm/W
F30110		30	12	10	100	7	546	78
F48110		48	12	10	62.5	11	858	78
F60210		48	24	10	100	11	858	78
F60110		60	12	10	50	14	1092	78
F60110		60	12	10	50	14	1092	78
F72210		72	24	10	83.3	16	1248	78
F96213		96	24	13.5	62.5	23	1794	78

5730 SINGLE COLOR SERIES

G36110		36	12	10	166.6	9	837	93
G60210		60	24	10	50	15	1395	93
G60110		60	12	10	100	15	1395	93
G60212		60	24	12	100	18	1620	90
G72212		72	24	12	83.3	20	1760	88

Color Options: ■ Red ■ Green ■ Blue ■ UV

SMD 6060 LENS

Big viewing angle
Perfect light distribution for light box

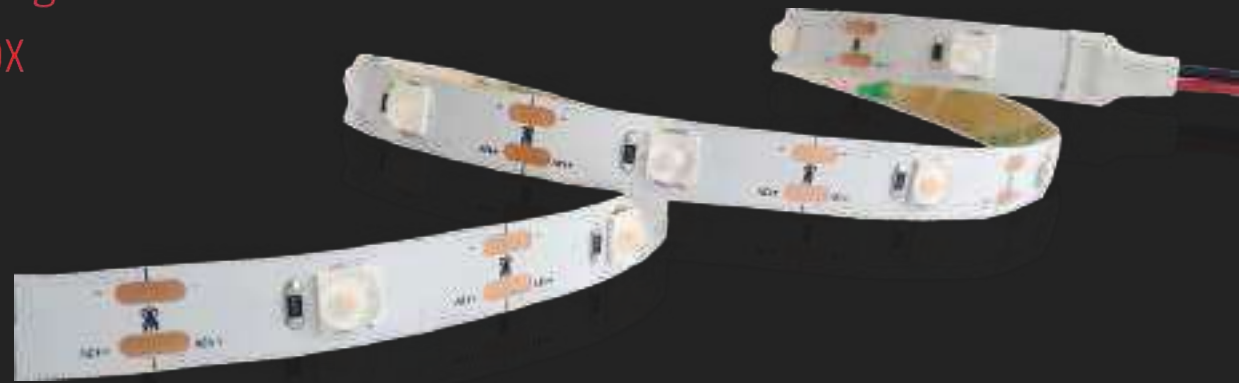

9

160° BEAM ANGLE SERIES

Item NO.	Photo	QTY/M	Voltage	W(mm)	Segment	W/M	Lm/M	Lm/W
K10108-S		10	12	8	100	6	85	510
K20108-S		20	12	8	50	9	85	765
K14110		14	12	10	71	12	85	1020
K28110		28	12	10	36	18	85	1530



CONSTANT CURRENT

High Efficiency up to 145LM
600mA Input CC driver
Max brightness up to 4200Lm

SUPER DENSITY

Ra>90
Up to 700LEDs on single meter
Dotless for aluminum profiles



ULTRA SLIM SERIES

A140203		140	24	3.5	50	4	360	90
B78103		78	12	3.5	38.4	4	360	90
B60104		60	12	4.5	50	5	450	90
B120205		120	24	5	50	7	630	90
B168205		168	24	5	41.6	8	840	105
G70205-CC		70	24	5	100	7	630	90
A224205		70	24	5	100	7	630	90

Color Options: ■ Red ■ Green ■ Blue ■ UV

COLOR RENDERING INDEX

CRI > 80



CRI > 95+



11

Standard LED CRI Values CRI > 80

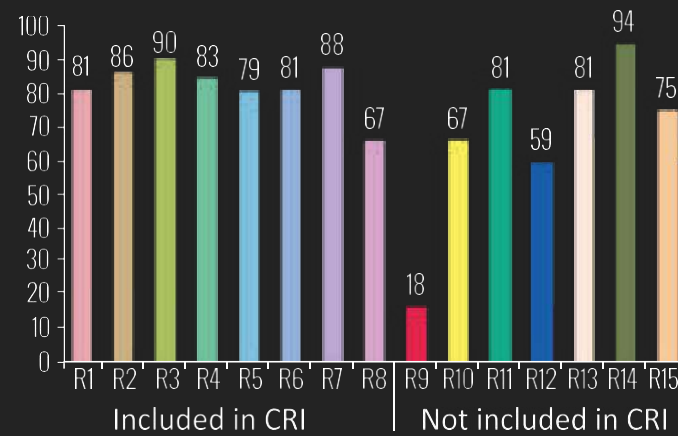

Premium LED CRI Values CRI > 95+

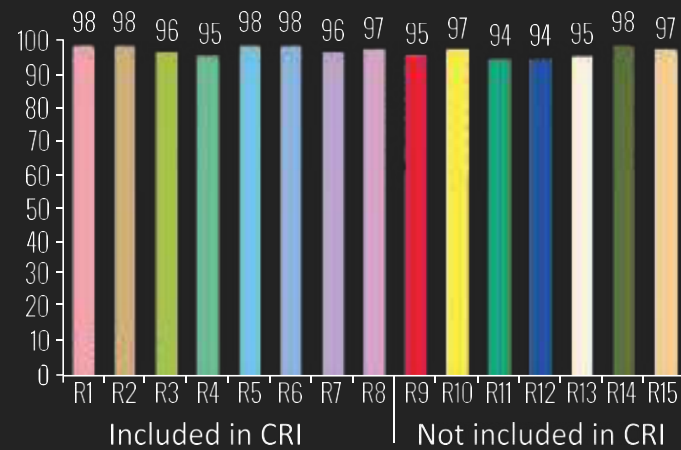

CRI 95+

The CRI is higher,
and the color is more natural.
Full range of WISVA LED are with CRI > 95,
presenting the true color for you.



SMD2835

SMD5050

CRI95+ SERIES

Item NO.	Photo	QTY/M	Voltage	W(mm)	Segment	W/M	Lm/M	Lm/W
B60210-21		60	24	10	100	12	840	70
B60210-25		60	24	10	100	12	852	71
B60210-30		60	24	10	100	12	864	72
B60210-35		60	24	10	100	12	876	73
B60210-40		60	24	10	100	12	888	74
B60210-62		60	24	10	100	12	900	75
F60210-21		60	24	10	100	14	1022	73
F60210-25		60	24	10	100	14	1036	74
F60210-30		60	24	10	100	14	1050	75
F60210-35		60	24	10	100	14	1064	76
F60210-40		60	24	10	100	14	1078	77
F60210-62		60	24	10	100	14	1092	78



30LED

60LED

120LED

3535 RGB

Pure color, mini LED, High density 120LED/M.

12



HIGH DENSITY RGB

Color Changing
Mini RGB LED,
more waterproof options.

RGB+CCT

5in1 Colors

Milight Controller
Multiple colors adjustable.



Multiple Colors

RGB FULL COLOR SERIES

Item NO.	Photo	QTY/M	Voltage	W(mm)	Segment	W/M	Lm/M	Lm/W
E30110-RGB		30	12	10	100	7.2	/	/
E60110-RGB		60	12	10	50	12	/	/
E60210-RGB		60	24	10	100	12	/	/
E120210-RGB		120	24	10	50	20	/	/
F30110-RGB		30	12	10	100	7	/	/
F60110-RGB		60	12	10	50	14	/	/
F96213-RGB		96	24	13.5	62.5	19	/	/
F120220-RGB		120	24	20	50	24	/	/
D120210-RGB		120	24	10	50	18	/	/

RGBW ADJUSTABLE SERIES

F60112-RGB30-4in1		60	12	12	50	14	/	/
F60112-RGB40-4in1		60	12	12	50	14	/	/
F60112-RGB30		60	12	12	100	9.6	/	/
F60214-RGBCCT-5in1		60	24	13.8	100	18	/	/
F96213-RGB30		96	24	13.5	125	15	/	/
CF180215-RGBCCT		180	24	15	100	21	/	/

CCT SERIES

Two chips in one LED gives a perfect mixed color



13

BENDABLE S TYPE SERIES

6mm width. Free turning
Spray glue Waterproof



GREAT WALL SERIES

3D Free Angle.



DUAL WHITE COLOR SERIES

Item NO.	Photo	QTY/M	Voltage	W(mm)	Segment	W/M	Lm/M	Lm/W
F60110-CCT-2in1		60	12	10	50	14.4	1080	75
J60108-CCT-2in1		60	12	8	50	12	960	80
J120210-CCT-2in1		120	24	10	50	20	1600	80
D120110-CCT		120	12	10	50	9.6	672	70
B120110-CCT		120	12	10	50	20	1800	90
F96213-CCT		96	24	13.5	125	23	1725	75
B240212-CCT		240	24	12	50	25	2300	82
A240210-CCT		240	24	10	50	20	1560	78

BENDABLE SERIES

B60106-S		60	12	6	50	4	360	90
B60108-S		60	12	8	50	6	540	90
B60106-S Ip54		60	12	6	50	4	320	80

Color Options: ■ Red ■ Green ■ Blue ■ UV

ONE LED CUT SERIES

Precise cutting every one LED



TWO LEDS CUT SERIES

Single and Dual white options.

14



FULL BEAM SERIES

220° View
No more Glare

GROW LIGHT SERIES

Energy saving 70% than HPS
Harvest 50% more than HPS

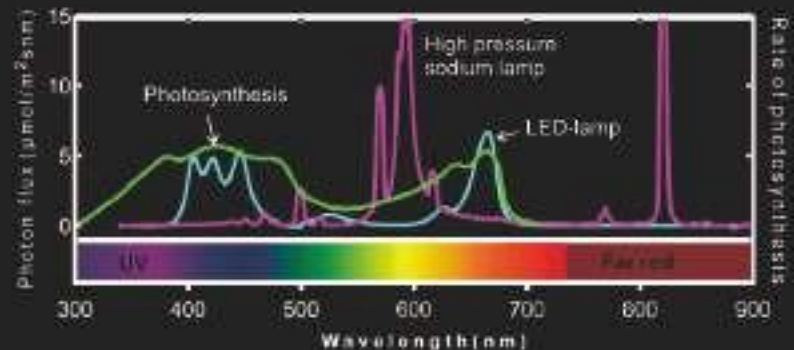
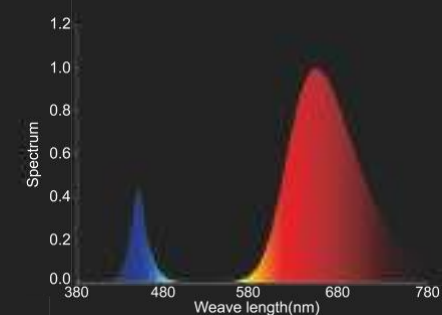

460nm and 660nm is the most effective photosynthesis spectrum
730nm, 6000K is important for growth adjustment.

ONE LED CUT SERIES

Item NO.	Photo	QTY/M	Voltage	W(mm)	Segment	W/M	Lm/M	Lm/W
B100110-30		100	12	10	10	22	1936	88
B120110		120	12	10	8.3	21	2100	100
B120210		120	24	10	8.3	21	2100	100

TWO LEDS CUT SERIES

F40210		40	24	10	50	8	640	80
F40110-CCT		40	12	10	50	8	640	80
F72210		72	24	10	27.7	17	1360	80

FULL BEAM SERIES

K120208		120	24	8	50	14	1120	80
Bi180212		180	24	12	100	18	1350	75

GROW LIGHT SERIES

B60210-R		60	24	10	100	12	/	/
B60210-B		60	24	10	100	12	/	/
B60210-RW		60	24	10	100	12	/	/
B60210-RB		60	24	10	100	12	/	/
B60210-P		60	24	10	100	12	/	/
B120210-P		120	24	10	50	20	/	/

CONSTANT CURRENT SERIES

15M running with TRIODE
20M running with IC

15



5V USB SERIES STRIPS LIGHT

Multiple colors
TV back lighting



CONSTANT CURRENT SERIES

Item NO.	Photo	QTY/M	Voltage	W(mm)	Segment	W/M	Lm/M	Lm/W
B30210-CC		30	24	10	200	6	540	90
B60210-CC		60	24	10	100	12	1080	90
B70210-CC		70	24	10	100	12	1200	100
B120210-CC		120	24	10	50	20	1800	90
B140210-CC		140	24	10	50	20	2000	100
F40210-CC		40	24	10	50	9	720	80
F60210-CC		60	24	10	100	14	1190	85
G70205-CC		70	24	5	100	7	630	90
G126212-CC		126	24	12	55.5	22	2090	95

5V USB SERIES

B60508		60	5	8	10	6	420	70
B60508-R		60	5	8	10	6	/	/
F30510-RGB		30	5	10	33.3	7	/	/

ADHESIVE TAPE



3M 200MP



Normal Indoor use

Adhesive Thickness
mils (mm) Adhesion to
Stainless Steel
5.2mils
(0.13 mm) 7.0N/CM

3M 300MP



Normal Indoor use

4.8mils
(0.12 mm) 8.6N/CM

16

3M 9080 Tape



Normal Indoor use

12.8mils
(0.32 mm) 7.5N/CM

3M 4229 Tape



For Waterproof Strips

30.4mils
(0.76 mm) 20.0N/CM

Tesa 4965

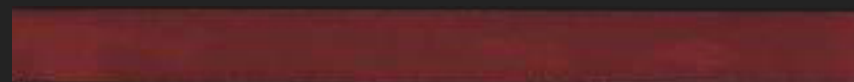

For Aluminum Profile

8.2mils
(0.205 mm) 14.0N/CM

Blue Tape



For High Wattage Strips

4.0mils
(0.10mm) 6.0N/CM



IP RATING



IP54-PU



PU Glue On The Surface

IP54-SI



Silicone Glue On The Surface

IP54-SP



Spray Silicone Glue On The Surface

IP54-ST



Silicone Tube On The Surface

IP65-ST



Silicone Tube On Both Sides

IP65-HT



HeatShrink Tube On Both Sides

IP65-Nano

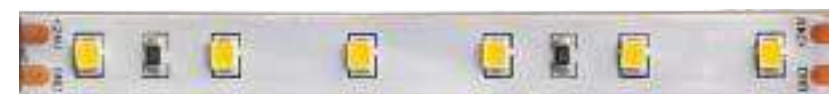

Nano Coating

IP67-HI



Hollow Integrated Silicone Glue

IP68-SI

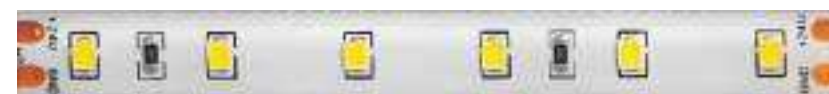

Solid Integrated Silicone Glue

Morning Go

LED ALUMINUM PROFILE



17

ACCESSORIES



LED ALUMINUM PROFILE



18

SINGLE ZONE SERIES



Mini LED CONTROLLER

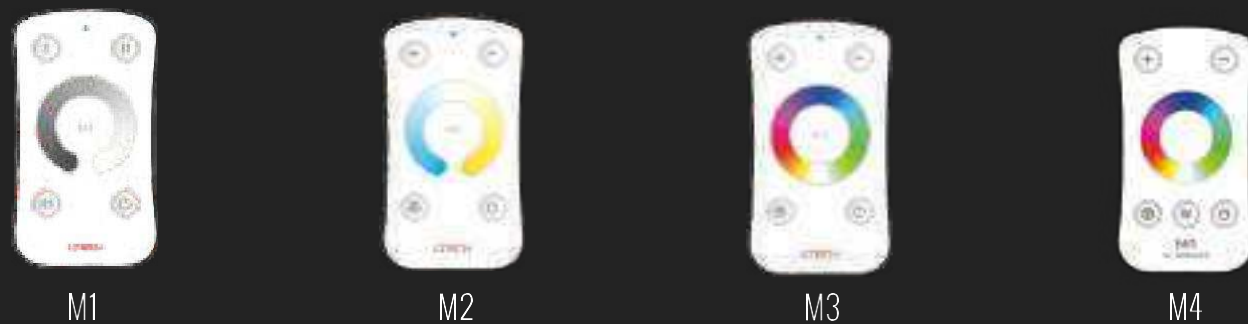

ACCESSORIES

